

Two-point contact
双点接触

Overview

WF2548 is a 2.54mm pitch wire to board connector, the product has both high density, high performance, high integration and other advantages, can effectively ensure the stability of the signal transmission and integrity, the board end to provide horizontal and vertical direction of the board mounting, to meet the customer's different angles of insertion and adaptation.

概述

WF2548是一款2.54mm间距线到板连接器，产品兼具高密度、高性能，高集成等优点，能有效确保信号传输的稳定性以及完整性，板端提供水平及垂直方向贴板安装，满足客户不同角度对插适配。

Features and Benefits

- Friction lock structure to prevent accidental dislodgement
- Anti-misplug structure, effectively avoiding misinsertion
- Straight and curved plugs available
- Wiring range 24-28AWG

产品特点

- 摩擦锁结构，防止意外脱落
- 防错插设计、有效避免错插
- 提供直插、弯插供选择
- 接线范围 24-28AWG

Product Applications

- Industrial equipment: automation equipment, robotics and control systems, sensors, control units
- Computers: motherboards, fans, hard drives
- Lighting equipment: LED lamps, lighting systems

应用领域

- 工业设备：自动化设备、机器人与控制系统、传感器、控制单元
- 计算机：主板、风扇、硬盘
- 照明设备：LED灯具、照明系统

Standard 标准

- EIA 364

UL certification UL认证

- E248993

Material 材料

Part/零件	Material/材料	Finish/电镀	UL Flame retardant/阻燃等级
Housing/主体	PBT	Black/黑色	UL94V-0
Header/板端	PA9T	White/白色 Black/黑色	UL94V-0
Terminal/端子	phosphor bronze 磷铜 (C5191)	Au or Sn plated 镀金或锡	-

Production Specifications 产品规格

Current rating 额定电流	3.0 A	Operating Temperature Range:-40° C~+105° (including temperature rise) Operating Humidity Range:20-80% 工作温度范围: -40° C~+105° C(含温升) 工作湿度范围: ≤80%	Storage Teroerature: Operating Humidity: 储存温度: 25±5° C 储存湿度: ≤60%
Voltage rating 额定电压	250V		

Item 项目	Condition 条件	Specification 规格
Insulation Resistance 绝缘电阻	Measured at 1000V DC for 1 minute 测试电压: 1000V DC/1分钟	No less than 1000M Ω 不少于1000MΩ
Withstanding voltage 耐电压	Measured at 1000V AC for 1 minute 测试电压: 1000V AC/1分钟	No breakdown, no discharge, leakage current <0.5mA 无击穿、无放电、漏电流<0.5mA
Contact Resistance 接触电阻	Measured at 100mA and no higher than 20mV 用20 mV DC进行测量	Contact resistance: Initial value/ 20 mo max After environmental tests/ 30 mo max. 接触电阻: 初始值 20 mΩ 以下 测试后 30 mΩ 以下
Vibration Resistance 抗振动	Frequency : 10 ~ 1000 Hz Accelerated Velocity : 5.35 Gms minimum Vibration Direction : X,Y,Z Duration : 8 h each 频率: 10 ~ 1000 Hz 加速度: 27.8 m/s ² 振动方向: X,Y,Z 振动时间: 各8小时	No electrical discontinuity of 1μs or greater 试验过程中未发生1μs瞬断现象, 且外观无损伤, 电气性能正常
Humidity (Steady state) 湿度	Temperature : 25~65°C Humidity: 90 ~95% (R.H) Duration : 96 hours 温度: 25~65° C 湿度: 90 ~95% (R.H) 时间: 96小时	Contact resistance: Initial value/ 20 mo max After environmental tests/ 30 mo max. 接触电阻: 初始值 20 mΩ 以下 测试后 30 mΩ 以下
Salt Spray 盐雾	Temperature:35#2°C Humidity:95~98%(R.H) PHValue : 6.5 ~ 7.2 Duration : 48hours (Gold Area) 温度: 35±2° C 湿度: 95~98%(R.H) PH值: 6.5~7.2 时间: 24小时	Contact resistance: Initial value/ 20 mo max After environmental tests/ 30 mo max. 接触电阻: 初始值 20 mΩ 以下 测试后 30 mΩ 以下
Durability(Mating/un- mating) 插拔寿命	500 cycles 循环500次	Contact resistance: Initial value/ 20 mo max After environmental tests/ 30 mo max. 接触电阻: 初始值 20 mΩ 以下 测试后 30 mΩ 以下

PCB Layout 印刷电路板布局

Through-hole type 通孔型

(Single Row S/T DIP、R/A DIP)



(Dual Row S/T DIP、R/A DIP)

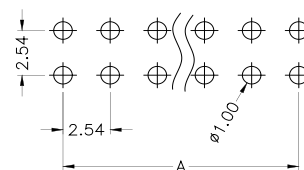

WF2548 Series

Ordering Information 订购信息

Circuit 芯数	Part number 型号		Dimensions 尺寸 (mm)			Package 包装 Q'ty/Bag 只/袋装		Remake 可量产状态	
	S/T DIP	R/A DIP	A	B	C	S/T DIP	R/A DIP	S/T DIP	R/A DIP
2	WF2548-1WS02X01	WF2548-1WR02X01	2.54	7.62	4.44	1000	1000	*	*
3	WF2548-1WS03X01	WF2548-1WR03X01	5.08	10.16	6.98	1000	500	*	*
4	WF2548-1WS04X01	WF2548-1WR04X01	7.62	12.70	9.52	1000	500	*	*
5	WF2548-1WS05X01	WF2548-1WR05X01	10.16	15.24	12.06	500	400	*	*
6	WF2548-1WS06X01	WF2548-1WR06X01	12.70	17.78	14.60	500	400	*	*
7	WF2548-1WS07X01	WF2548-1WR07X01	15.24	20.32	17.14	500	300		
8	WF2548-1WS08X01	WF2548-1WR08X01	17.78	22.86	19.68	500	300	*	*
9	WF2548-1WS09X01	WF2548-1WR09X01	20.32	25.40	22.22	400	200	*	*
10	WF2548-1WS10X01	WF2548-1WR10X01	22.86	27.94	24.76	400	200	*	*
11	WF2548-1WS11X01	WF2548-1WR11X01	25.40	30.48	27.30	300	200	*	*
12	WF2548-1WS12X01	WF2548-1WR12X01	27.94	33.02	29.84	300	200	*	*
13	WF2548-1WS13X01	WF2548-1WR13X01	30.48	35.56	32.38	200	100		
14	WF2548-1WS14X01	WF2548-1WR14X01	33.02	38.10	34.92	200	100	*	*
15	WF2548-1WS15X01	WF2548-1WR15X01	35.56	40.64	37.46	200	100	*	*
16	WF2548-1WS16X01	WF2548-1WR16X01	38.10	43.18	40.00	200	100		
17	WF2548-1WS17X01	WF2548-1WR17X01	40.64	45.72	42.54	200	100		
18	WF2548-1WS18X01	WF2548-1WR18X01	43.18	48.26	45.08	100	100		
19	WF2548-1WS19X01	WF2548-1WR19X01	45.72	50.80	47.62	100	100		
20	WF2548-1WS20X01	WF2548-1WR20X01	48.26	53.34	50.16	100	100		
21	WF2548-1WS21X01	WF2548-1WR21X01	50.80	55.88	52.70	100	100		
22	WF2548-1WS22X01	WF2548-1WR22X01	53.34	58.42	55.24	100	100		

Note: * stands for mass production . 注: *代表可量产

Dimensions 尺寸 (S/T DIP)

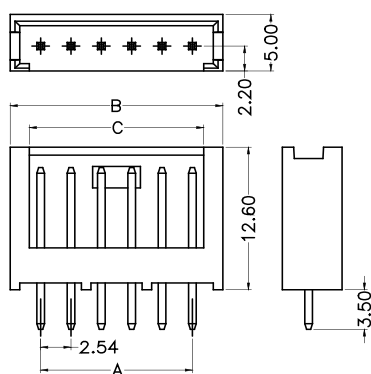

Dimensions 尺寸 (R/A DIP)

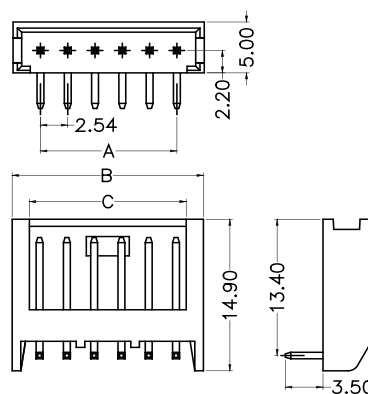

Assembly Schematic 装配示意

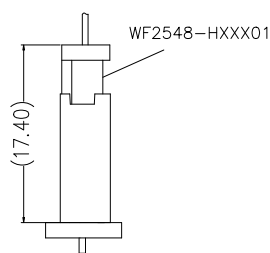

Assembly Schematic 装配示意

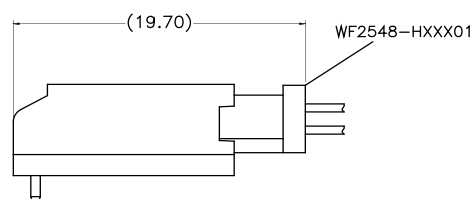

Ordering Information 订购信息

Circuit 芯数	Part number 型号		Dimensions 尺寸 (mm)			Package 包装 Q'ty/Bag 只/袋装		Remake 可量产状态	
	S/T DIP	R/A DIP	A	B	C	S/T DIP	R/A DIP	S/T DIP	R/A DIP
3	WF2548-2WS03X01	WF2548-2WR03X01	5.08	10.16	6.98	500	200	*	*
4	WF2548-2WS04X01	WF2548-2WR04X01	7.62	12.70	9.52	300	200	*	*
5	WF2548-2WS05X01	WF2548-2WR05X01	10.16	15.24	12.06	300	200	*	*
6	WF2548-2WS06X01	WF2548-2WR06X01	12.70	17.78	14.60	300	200	*	*
7	WF2548-2WS07X01	WF2548-2WR07X01	15.24	20.32	17.14	300	150	*	*
8	WF2548-2WS08X01	WF2548-2WR08X01	17.78	22.86	19.68	300	150	*	*
9	WF2548-2WS09X01	WF2548-2WR09X01	20.32	25.40	22.22	300	150		
10	WF2548-2WS10X01	WF2548-2WR10X01	22.86	27.94	24.76	200	100		
11	WF2548-2WS11X01	WF2548-2WR11X01	25.40	30.48	27.30	200	100		
12	WF2548-2WS12X01	WF2548-2WR12X01	27.94	33.02	29.84	200	100	*	*
13	WF2548-2WS13X01	WF2548-2WR13X01	30.48	35.56	32.38	200	100		
14	WF2548-2WS14X01	WF2548-2WR14X01	33.02	38.10	34.92	200	100		
15	WF2548-2WS15X01	WF2548-2WR15X01	35.56	40.64	37.46	100	100		
16	WF2548-2WS16X01	WF2548-2WR16X01	38.10	43.18	40.00	100	50		
17	WF2548-2WS17X01	WF2548-2WR17X01	40.64	45.72	42.54	100	50		
18	WF2548-2WS18X01	WF2548-2WR18X01	43.18	48.26	45.08	100	50		
19	WF2548-2WS19X01	WF2548-2WR19X01	45.72	50.80	47.62	100	50		
20	WF2548-2WS20X01	WF2548-2WR20X01	48.26	53.34	50.16	100	50	*	*
21	WF2548-2WS21X01	WF2548-2WR21X01	50.80	55.88	52.70	100	50		
22	WF2548-2WS22X01	WF2548-2WR22X01	53.34	58.42	55.24	100	50	*	*

Note: * stands for mass production . 注: *代表可量产

Dimensions 尺寸 (S/T DIP)

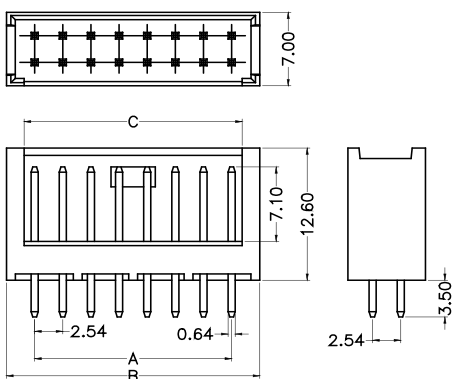

Dimensions 尺寸 (R/A DIP)

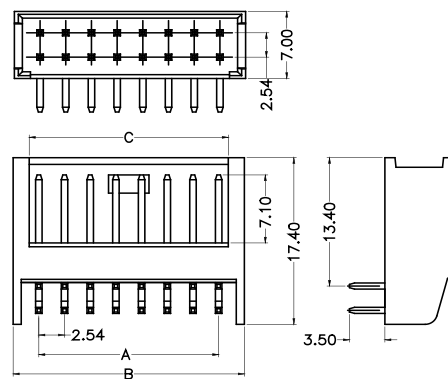

Assembly Schematic 装配示意

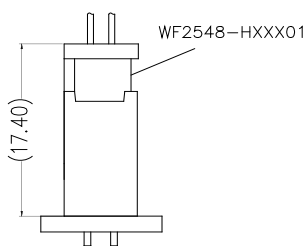

Assembly Schematic 装配示意

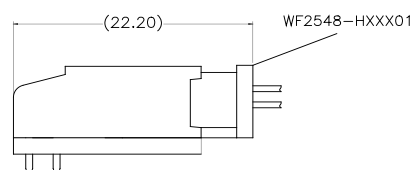

WF2548 Series

Dimensions 尺寸

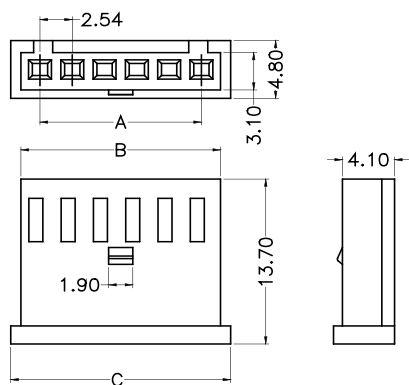

Ordering Information 订购信息

Circuit 芯数	Part number 型号	Dimensions 尺寸 (mm)			Package 包装 Qty/Bag 只/袋装	Remake 可量产状态
		A	B	C		
2	WF2548-1H02B01	2.54	5.60	7.10	3500	*
3	WF2548-1H03B01	5.08	8.14	9.64	2500	*
4	WF2548-1H04B01	7.62	10.68	12.18	2000	*
5	WF2548-1H05B01	10.16	13.22	14.72	1500	*
6	WF2548-1H06B01	12.70	15.76	17.26	500	*
7	WF2548-1H07B01	15.24	18.30	19.80	500	
8	WF2548-1H08B01	17.78	20.84	22.34	500	*
9	WF2548-1H09B01	20.32	23.38	24.88	500	*
10	WF2548-1H10B01	22.86	25.92	27.42	500	*
11	WF2548-1H11B01	25.40	28.46	29.96	500	
12	WF2548-1H12B01	27.94	31.00	32.50	500	*
13	WF2548-1H13B01	30.48	33.54	35.04	400	
14	WF2548-1H14B01	33.02	36.08	37.58	400	*
15	WF2548-1H15B01	35.56	38.62	40.12	200	
16	WF2548-1H16B01	38.10	41.16	42.66	200	
17	WF2548-1H17B01	40.64	43.70	45.20	200	
18	WF2548-1H18B01	43.18	46.24	47.74	200	
19	WF2548-1H19B01	45.72	48.78	50.28	200	
20	WF2548-1H20B01	48.26	51.32	52.82	100	
21	WF2548-1H21B01	50.80	53.86	55.36	100	
22	WF2548-1H22B01	53.34	56.40	57.90	100	

Adaptor Terminal 适配端子 (WF2548-TPXX01/2)

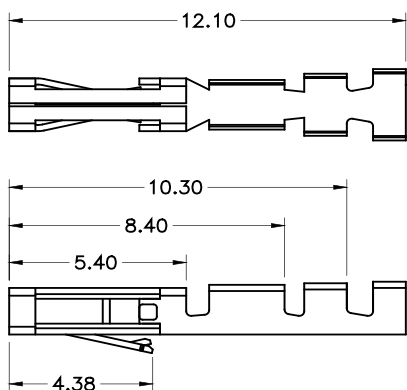

Note: * stands for mass production . 注: *代表可量产

Dimensions 尺寸

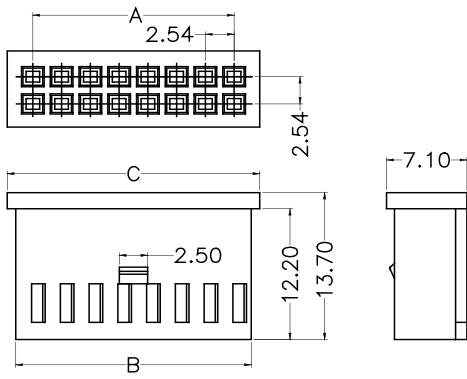

Ordering Information 订购信息

Circuit 芯数	Part number 型号	Dimensions 尺寸 (mm)			Package 包装 Q'ty/Bag 只/袋装	Remake 可量产状态
		A	B	C		
3	WF2548-2H03B01	5.08	8.14	9.64	1000	*
4	WF2548-2H04B01	7.62	10.68	12.18	700	*
5	WF2548-2H05B01	10.16	13.22	14.72	400	*
6	WF2548-2H06B01	12.70	15.76	17.26	400	
7	WF2548-2H07B01	15.24	18.30	19.80	300	
8	WF2548-2H08B01	17.78	20.84	22.34	300	*
9	WF2548-2H09B01	20.32	23.38	24.88	200	*
10	WF2548-2H10B01	22.86	25.92	27.42	200	
11	WF2548-2H11B01	25.40	28.46	29.96	200	
12	WF2548-2H12B01	27.94	31.00	32.50	200	*
13	WF2548-2H13B01	30.48	33.54	35.04	200	
14	WF2548-2H14B01	33.02	36.08	37.58	200	
15	WF2548-2H15B01	35.56	38.62	40.12	100	*
16	WF2548-2H16B01	38.10	41.16	42.66	100	
17	WF2548-2H17B01	40.64	43.70	45.20	100	
18	WF2548-2H18B01	43.18	46.24	47.74	100	*
19	WF2548-2H19B01	45.72	48.78	50.28	100	
20	WF2548-2H20B01	48.26	51.32	52.82	100	*
21	WF2548-2H21B01	50.80	53.86	55.36	100	
22	WF2548-2H22B01	53.34	56.40	57.90	100	*

Adaptor Terminal 适配端子 (WF2548-TPXX01/2)

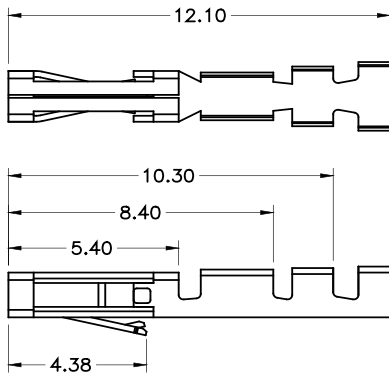

Terminal Crimp specification 端子压接规范

型号 Model number	电线类型 Wire type	电线规格 Wire size	线缆 OD (mm) Cable OD (mm)	剥线长度 (mm) Strip length (mm)	导体铆压 (A-A) Conductor crimp			绝缘体铆压 (B-B) Insulation crimp	
					压接宽度CB1 Crimping width CB1±0.03mm	压接宽度CBm1 Crimping width CBm1+0.05mm	压接高度 Crimping height CH1±0.03mm	压接宽度CBm2 Crimping width CBm2±0.05mm	压接高度CH2 Crimping height CH2±0.08mm
WF2548-TPXX01	UL 1569	24 AWG	1.40	2.30±0.3mm	1.31	1.35	0.67	1.62	1.13
WF2548-TPXX02	UL 1061	26 AWG	0.90		1.27	1.33	0.64	1.62	1.37
	UL 1007	28 AWG	1.20		1.27	1.32	0.63	1.63	1.39

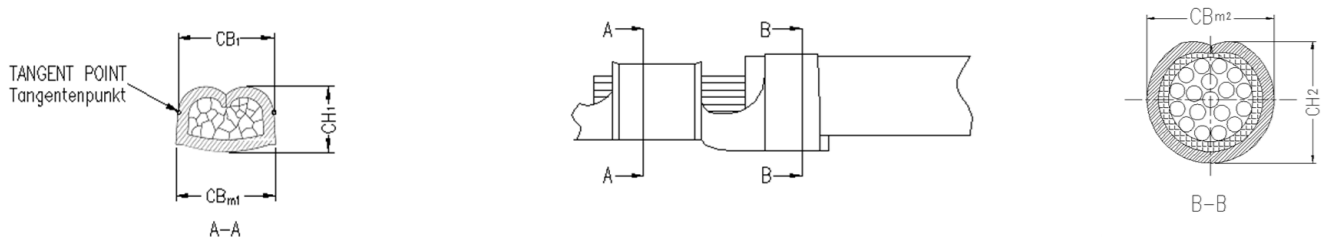

WF2548 Series

Model number allocation 型号命名

WF2548	-	X	XX	XX	XX	X	X	1
(1)		(2)	(3)	(4)	(5)	(6)	(7)	(8)
(1) Series (系列): Wafer 2.54mm Series					(5) plating (电镀): Blank=Tin、S0=Gold Flash/Tin、S3=10u"Gold/Tin、S4=15u"Gold/Tin、S5=30u"Gold/Tin			
(2) Row (排数): 1=Single Row 2=Dual Row					(6) Color(颜色): W=White、B=Black			
(3) Terminal type(端子形态): WS=S/T DIP WR=R/A DIP					(7) Packing(包装): 0=PE Bag、T=Tuble			
(4) Circuit(位数): 02=2.....22=22P					(8) Internal code(流水码)			

WF2548	-	X	H	XX	B	0	1
(1)		(2)	(3)	(4)	(5)	(6)	(7)
(1) Series (系列): Wafer 2.50mm Series					(5) Color(颜色): B=Black		
(2) Row (排数): 1=Single Row 2=Dual Row					(6) Packing(包装): 0=PE Bag		
(3) Product type(产品类型): H=Crimp Type Housing					(7) Internal code(流水码)		
(4) Circuit(位数): 02=2.....22=22P							

Contact Us 联系我们

维峰电子股份有限公司(总部)
WCON ELECTRONICS CO.,LTD(HQ)
地址:广东省东莞市虎门镇大宁文明路15号
Add :No.15,Wenming Road,Daning Community, Humen Town, Dongguan, Guangdong.523930, China

昆山维康电子有限公司
KUNSHAN WCON ELECTRONICIS CO.,LTD(East of China)
地址:江苏昆山千灯镇石浦新虹路321号
Add : No.321, Xinhong Road, Shipu, QiandengTown, Kunshan, Jiangsu, China

合肥维峰电子有限公司
HEFEI WCON ELECTRONICIS CO.,LTD
地址:安徽合肥市高新技术开发区绿城科技园E栋2楼
Add : 2F, Building E, Greentown Science Park,High-tech Development Zone, Hefei, Anhui,China

维康电子(泰国)有限公司
WCON ELECTRONICS (Thailand) CO.,LTD
地址:泰国巴真武里府西玛铺县华瓦区洛加纳工业园
Add: VG3C+H57, Hua Wa, Si Maha Phot District, Prachin Buri 25140, Thailand

销售联系方式 Sales Contacts

国际客户部 International Sales Department
salesdg01@wcon.com
salesdg05@wcon.com

大客户专线 Key Account Line
华南: salesdg28@wcon.com
华东: salesks@wcon.com

中小客户专线 Small and Medium-sized Account Line
华南: salesdg10@wcon.com
华东: salesks01@wcon.com

网络销售 Online sales
salesdg26@wcon.com



Official Website



Product e-catalog



WeChat Public#



TikTok Public#