

WF2002 Series

WF2002系列

2.00mm pitch/Wire-to-board Connector

2.00mm间距/线到板连接器

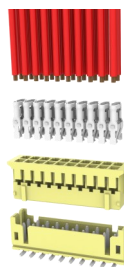
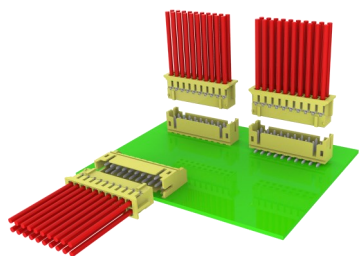

Two-point contact
两点接触

Overview

WF2002 series products are 2.00mm pitch high density, small size, double contact design can give the product contact stability, vibration resistance, shock resistance, and can provide-signal transmission for the device to provide a wire-to-board connector.

概述

WF2002系列产品是一款2.00mm间距高密度、小体积，双触点的设计能给予产品接触稳定、抗振动、耐冲击的性能，同时能为设备提供信号传输的线到板连接器。

Features and Benefits

- Friction lock design to enhance the stability of fit
- Dual contact design, stable contact
- Small size, high density
- Vibration and shock resistant

产品特点

- 摩擦锁扣设计，增强配合稳定性
- 双触点设计、接触稳定
- 小体积、高密度
- 抗振动、耐冲击

Product Applications

- Industrial: Robotic arm, industrial computer

应用领域

- 工业：机械手臂、工业计算机

Standard 标准

- EIA-364

UL certification UL认证

- E248993

Material 材料

Part/零件	Material/材料	Finish/电镀	UL Flame retardant/阻燃等级
Housing/主体	PA66	White/白色 Beige/米黄色	UL94V-0
Header/板端	PA46/PA66	Black/黑色 White/白色 Beige/米黄色	UL94V-0
Terminal/端子	phosphor bronze 磷铜 (C5191)	Gold or Tin plated 镀金或镀锡	-

Production Specifications 产品规格

Current rating 额定电流	2.0A	Operating temperature Range:-40° C~+105° C (including temperature rise) Operating Humidity Range:20-80% 工作温度范围: -40° C~+105° C(含温升) 工作湿度范围: 20-80%	Storage temperature: Operating Humidity: 储存温度: 25±5° C 储存湿度: ≤60%
Voltage rating 额定电压	250V		

Item 项目	Condition 条件	Specification 规格
Insulation Resistance 绝缘电阻	Measured at 500V DC for 1 minute 测试电压: 500V DC/1分钟	No less than 100MΩ 不少于100MΩ
Withstanding voltage 耐电压	Measured at 800V AC for 1 minute 测试电压: 800V AC/1分钟	No breakdown, no discharge, leakage current <0.5mA 无击穿、无放电、漏电流<0.5mA
Contact Resistance 接触电阻	Measured at 100mA and no higher than 20mV 用20 mV DC进行测量	Contact resistance: Initial value/ 20 mΩ max After environmental tests/ 30 mΩ max. 接触电阻: 初始值 20 mΩ 以下 测试后 30 mΩ 以下
Vibration Resistance 抗振动	Frequency : 50 ~ 2000 Hz PSD value : 5.35 Gms minimum Duration : 15 minutes/axis Times : Each of three mutually perpendicular planes. 频率: 50 ~ 2000 Hz PSD 值: 5.35 Gms 时长: 15分钟/轴	No electrical discontinuity of 1μs or greater 试验过程中未发生1μs瞬断现象, 且外观无损伤, 电气性能正常
Humidity (Steady state) 湿度	Temperature : 25~65°C Humidity: 90 ~95% (R.H) Duration : 96 hours 温度: 25~65° C 湿度: 90 ~95% (R.H) 时间: 96小时	Contact resistance: Initial value/ 20 mΩ max After environmental tests/ 30 mΩ max. 接触电阻: 初始值 20 mΩ 以下 测试后 30 mΩ 以下
Salt Spry 盐雾	Temperature:35± 2°C Solution concentration : 5%NaCl PHValue : 6.5 ~ 7.2 Duration : 24hours 温度: 35±2° C 溶液浓度: 5%NaCl PH值: 6.5~7.2 时间: 24小时	Contact resistance: Initial value/ 20 mΩ max After environmental tests/ 30 mΩ max. 接触电阻: 初始值 20 mΩ 以下 测试后 30 mΩ 以下
Durability(Mating/un-mating) 插拔寿命	30 cycles 循环30次	Contact resistance: Initial value/ 20 mΩ max After environmental tests/ 30 mΩ max. 接触电阻: 初始值 20 mΩ 以下 测试后 30 mΩ 以下

PCB Layout 印刷电路板布局

(S/T)SMT type 表面贴装型

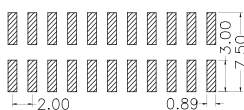

(S/T)DIP type 插孔装型

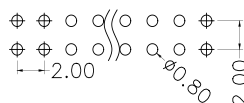

(R/A)DIP type 插孔装型

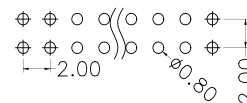

WF2002 Series

Ordering Information 订购信息

Circuit 芯数	Part number 型号			Dimensions 尺寸 (mm)		Package 包装 Q'ty/Tube 只/管装			Remake 可量产状态		
	S/T SMT	S/T DIP	R/A DIP	A	B	S/T SMT	S/T DIP	R/A DIP	S/T SMT	S/T DIP	R/A SMT
4	WF2002-WMX04XXXXX	WF2002-WSX04XXXXX	WF2002-WRX04XXXXX	4.00	2.00	99	99	99	*	*	*
6	WF2002-WMX06XXXXX	WF2002-WSX06XXXXX	WF2002-WRX06XXXXX	6.00	4.00	74	74	74	*	*	*
8	WF2002-WMX08XXXXX	WF2002-WSX08XXXXX	WF2002-WRX08XXXXX	8.00	6.00	59	59	59	*	*	*
10	WF2002-WMX10XXXXX	WF2002-WSX10XXXXX	WF2002-WRX10XXXXX	10.00	8.00	49	49	49	*	*	*
12	WF2002-WMX12XXXXX	WF2002-WSX12XXXXX	WF2002-WRX12XXXXX	12.00	10.00	41	41	41	*	*	*
14	WF2002-WMX14XXXXX	WF2002-WSX14XXXXX	WF2002-WRX14XXXXX	14.00	12.00	36	36	36	*	*	*
16	WF2002-WMX16XXXXX	WF2002-WSX16XXXXX	WF2002-WRX16XXXXX	16.00	14.00	32	32	32	*	*	*
18	WF2002-WMX18XXXXX	WF2002-WSX18XXXXX	WF2002-WRX18XXXXX	18.00	16.00	29	29	29	*	*	*
20	WF2002-WMX20XXXXX	WF2002-WSX20XXXXX	WF2002-WRX20XXXXX	20.00	18.00	26	26	26	*	*	*
22	WF2002-WMX22XXXXX	WF2002-WSX22XXXXX	WF2002-WRX22XXXXX	22.00	20.00	24	24	24	*	*	*
24	WF2002-WMX24XXXXX	WF2002-WSX24XXXXX	WF2002-WRX24XXXXX	24.00	22.00	22	22	22	*	*	*
26	WF2002-WMX26XXXXX	WF2002-WSX26XXXXX	WF2002-WRX26XXXXX	26.00	24.00	20	20	20	*	*	*
28	WF2002-WMX28XXXXX	WF2002-WSX28XXXXX	WF2002-WRX28XXXXX	28.00	26.00	19	19	19	*	*	*
30	WF2002-WMX30XXXXX	WF2002-WSX30XXXXX	WF2002-WRX30XXXXX	30.00	28.00	17	17	17	*	*	*
32	WF2002-WMX32XXXXX	WF2002-WSX32XXXXX	WF2002-WRX32XXXXX	32.00	30.00	16	16	16	*	*	*
34	WF2002-WMX34XXXXX	WF2002-WSX34XXXXX	WF2002-WRX34XXXXX	34.00	32.00	15	15	15	*	*	*
36	WF2002-WMX36XXXXX	WF2002-WSX36XXXXX	WF2002-WRX36XXXXX	36.00	34.00	14	14	14	*	*	*
38	WF2002-WMX38XXXXX	WF2002-WSX38XXXXX	WF2002-WRX38XXXXX	38.00	36.00	14	14	14	*	*	*
40	WF2002-WMX40XXXXX	WF2002-WSX40XXXXX	WF2002-WRX40XXXXX	40.00	38.00	13	13	13	*	*	*
42	WF2002-WMX42XXXXX	WF2002-WSX42XXXXX	WF2002-WRX42XXXXX	42.00	40.00	12	12	12	*	*	*
44	WF2002-WMX44XXXXX	WF2002-WSX44XXXXX	WF2002-WRX44XXXXX	44.00	42.00	12	12	12	*	*	*
46	WF2002-WMX46XXXXX	WF2002-WSX46XXXXX	WF2002-WRX46XXXXX	46.00	44.00	11	11	11	*	*	*
48	WF2002-WMX48XXXXX	WF2002-WSX48XXXXX	WF2002-WRX48XXXXX	48.00	46.00	11	11	11	*	*	*
50	WF2002-WMX50XXXXX	WF2002-WSX50XXXXX	WF2002-WRX50XXXXX	50.00	48.00	10	10	10	*	*	*

Note: * stands for mass production. 注: *代表可量产

Dimensions 尺寸 (S/T SMT)

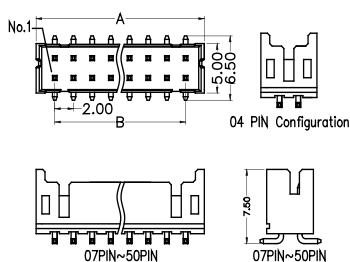

Dimensions 尺寸 (S/T DIP)

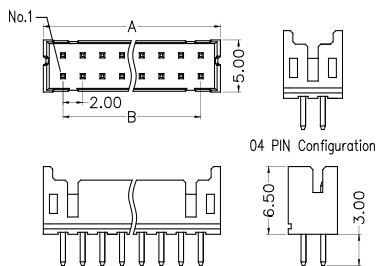

Dimensions 尺寸 (R/A DIP)

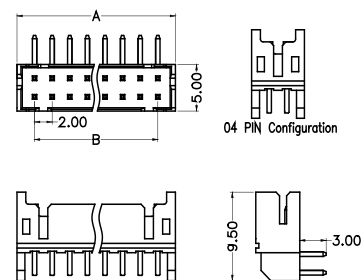

Assembly Schematic 装配示意

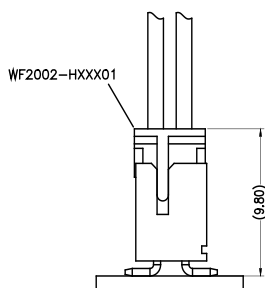

Assembly Schematic 装配示意

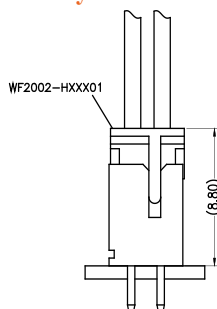

Assembly Schematic 装配示意

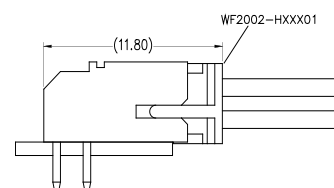

Dimensions 尺寸

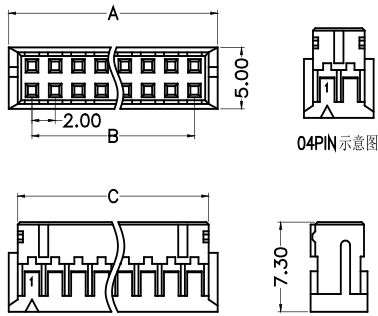

Ordering Information 订购信息

Circuit 芯数	Part number 型号	Dimensions 尺寸 (mm)			Package 包装 Q'ty/Bag 只/袋装	Remake 可量产状态
		A	B	C		
4	WF2002-H04X01	6.00	2.00	4.45	1,000	*
6	WF2002-H06X01	8.00	4.00	6.45	1,000	*
8	WF2002-H08X01	10.00	6.00	8.45	1,000	*
10	WF2002-H10X01	12.00	8.00	10.45	1,000	*
12	WF2002-H12X01	14.00	10.00	12.45	1,000	*
14	WF2002-H14X01	16.00	12.00	14.45	1,000	*
16	WF2002-H16X01	18.00	14.00	16.45	1,000	*
18	WF2002-H18X01	20.00	16.00	18.45	1,000	*
20	WF2002-H20X01	22.00	18.00	20.45	1,000	*
22	WF2002-H22X01	24.00	20.00	22.45	1,000	*
24	WF2002-H24X01	26.00	22.00	24.45	1,000	*
26	WF2002-H26X01	28.00	24.00	26.45	1,000	*
28	WF2002-H28X01	30.00	26.00	28.45	1,000	*
30	WF2002-H30X01	32.00	28.00	30.45	1,000	*
32	WF2002-H32X01	34.00	30.00	32.45	1,000	*
34	WF2002-H34X01	36.00	32.00	34.45	1,000	*
36	WF2002-H36X01	38.00	34.00	36.45	1,000	*
38	WF2002-H38X01	40.00	36.00	38.45	1,000	*
40	WF2002-H40X01	42.00	38.00	40.45	1,000	*

Adaptor Terminal 适配端子

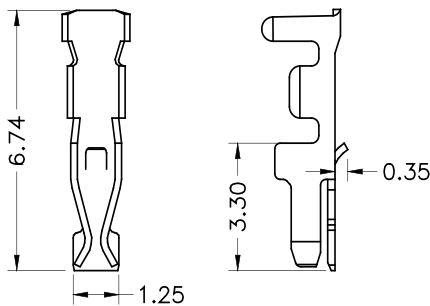

Note: * stands for mass production . 注: *代表可量产

型号 Model number	WF2002-TPXX0X
--------------------	---------------

Terminal Crimp specification 端子压接规范

型号 Model number	电线类型 Wire type	电线规格 Wire size	线缆 OD (mm) Cable OD (mm)	剥线长度 (mm) Strip length (mm)	导体铆压 (A-A) Conductor crimp			绝缘体铆压 (B-B) Insulation crimp	
					压接宽度CB1(mm) Crimping width (mm)	压接宽度CBm1 Crimping width (mm)	压接高度CH1(mm) Crimping height (mm)	压接宽度ICWmm Crimping width (mm)	压接高度ICHmm Crimping height (mm)
WF2002-TPXX01	UL1007	22AWG	0.9~1.50	2.0±0.2	not applicable 不适用				
	UL1007	24AWG			1.18	1.21	0.62	1.44	1.31
	UL1007	26AWG			1.16	1.21	0.61	1.43	1.05
	UL1007	28AWG			1.16	1.21	0.61	1.41	1.00
WF2002-TPXX02	UL1007	22AWG	1.0~1.50	2.0±0.2	1.2	1.25	0.86	1.56	1.85
	UL1007	24AWG			1.2	1.25	0.76	1.5	1.57
WF2002-TPXX03	UL1007	26AWG	0.9~1.10	2.0±0.2	1.18	1.21	0.66	1.48	1.47
	UL1007	28AWG			not applicable / 不适用				

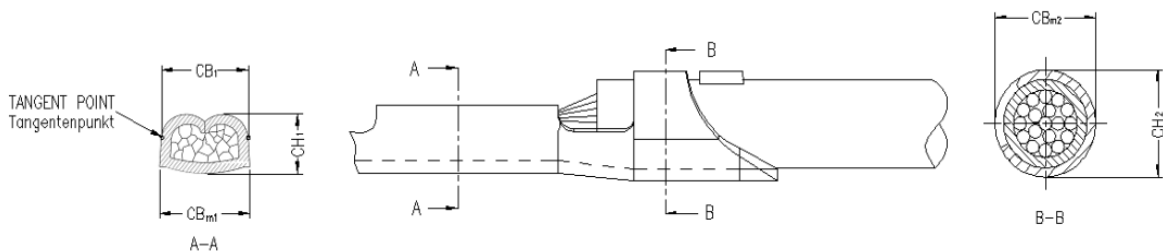

WF2002 Series

Model number allocation 型号命名

WF2002	-	XX	X	XX	XX	X	X	X
(1)		(2)	(3)	(4)	(5)	(6)	(7)	(8)
(1) Series (系列): Wafer 2.00mm Series					(5) Plating(电镀): S0=Gold Flash/Tin、S3=10u"Gold/Tin、S4=15u"Gold/Tin、S5=30u"Gold/Tin、G0=Gold Flash、G3=10u"Gold、G4=15u"Gold、G5=30u"Gold、Blank=Tin			
(2) Terminal type(端子形态): WM=S/T SMT、WS=S/T DIP、WR=R/A DIP					(6) Color(颜色): B=Black、E=Beige、T=Natural			
(3) Insulator Material(绝缘材料): H=PA46、Blank=PA66					(7) Packing(包装): R=Tape&Reel、T=Tube			
(4) Circuit(位数): 04=4P.....50=50P					(8) Internal code(流水码)			

WF2002	-	H	XX	B	0	1
(1)		(2)	(3)	(4)	(5)	(6)
(1) Series (系列): Wafer 2.00mm Series			(4) Color(颜色): W=White、E=Beige			
(2) Product type(产品类型): H=Crimp Type Housing			(5) Packing(包装): 0=PE Bag			
(3) Circuit(位数): 04=4P.....40=40P			(6) Internal code(流水码)			

Contact Us 联系我们

维峰电子股份有限公司(总部)
WCON ELECTRONICS CO.,LTD(HQ)
地址:广东省东莞市虎门镇大宁文明路15号
Add :No.15,Wenming Road,Daning Community, Humen Town, Dongguan, Guangdong.523930, China

昆山维康电子有限公司
KUNSHAN WCON ELECTRONICIS CO.,LTD(East of China)
地址:江苏昆山千灯镇汶浦中路169号
Add : No.169, WenPu Middle Road, QianDeng Town, Kunshan City, Jiangsu Province, China

合肥维峰电子有限公司
HEFEI WCON ELECTRONICIS CO.,LTD
地址:安徽合肥市高新技术开发区绿城科技园E栋2楼
Add : 2F, Building E, Greentown Science Park,High-tech Development Zone, Hefei, Anhui,China

维康电子(泰国)有限公司
WCON ELECTRONICS (Thailand) CO.,LTD
地址:泰国巴真武里府西玛玛县华瓦区洛加纳工业园
Add: VG3C+H57, Hua Wa, Si Maha Phot District, Prachin Buri 25140, Thailand

销售联系方式 Contacts Information

国际客户部 International sales department
salesdg01@wcon.com
salesdg05@wcon.com

大客户专线 Major customer dedicated department
华南: salesdg28@wcon.com
华东: salesks@wcon.com

中小客户专线 Public Customer hot line
华南: salesdg10@wcon.com
华东: salesks01@wcon.com

网络销售 Online sales department
salesdg26@wcon.com



Official Website



Product e-catalog



WeChat Public#



TikTok Public#