

Recommended P.C.B Layout (Top Side)
(PCB BOARD TOLERANCE ± 0.05)

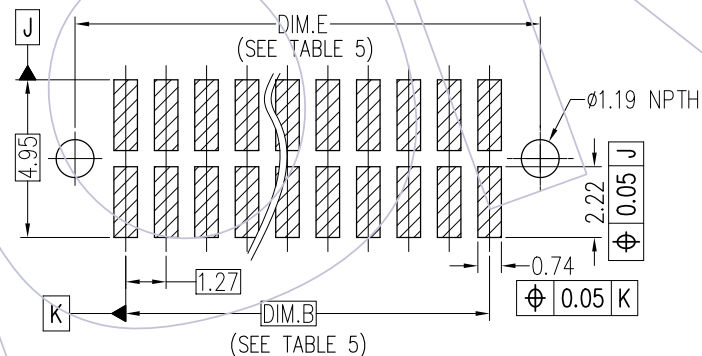

FIG. 2
WITHOUT NOTCH
(SAME AS FIG. 1, DIFFERENT AS SHOWN)

				OPERATION	DRAW	DATE	SCALE	FIT	PART NO.
				x.x ±0.40	Ken	2021/10/20	UNIT	mm	3601-SXXX-DX1MXXXX1
				x.xx ±0.25	CHECK	DATE	SIZE	A4	TITLE:
AO	2021/10/20	NEW	Ken	x.xxx ±0.15	APPROVE	DATE	SHEET	2/8	1.27mm BTB Female Header W=3.05, -SN STYLE, SMT
REV	DATE	MODIFICATION DESCRIPTION	CHANGE	Angle ± 3°			PROJ.	Customer NO.	
				DIM TOL					

WCON

Http: www.wcon.com

WCON-Dongguan	WCON-Kunshan
Tel: +86 769 85358920	Tel: +86 512 57468408
Fax: +86 769 85358915	Fax: +86 512 57468468
E-mail: sales@wcon.com	E-mail: salesks@wcon.com

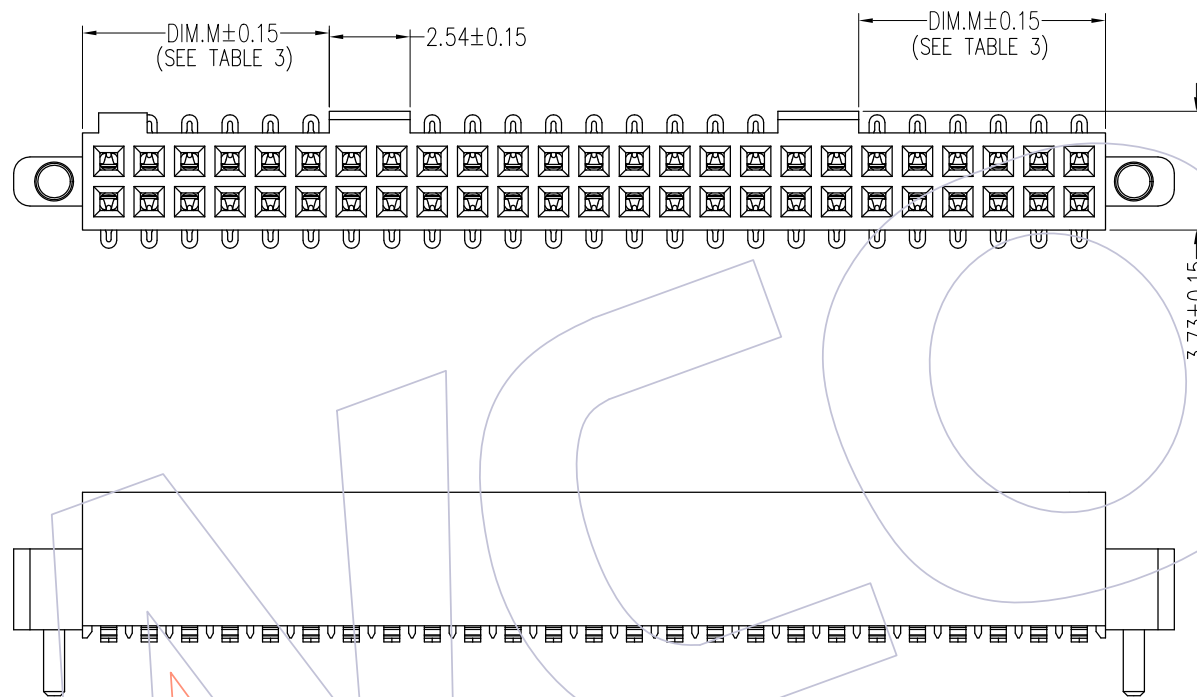

TABLE 3

NO. OF POS.	DIM.M
05, 07, 08	2.03
10 THRU 50	7.75

FIG. 3
HOUSING WITH LOCKING
POSITION 25 PER ROW
(SAME AS FIG.1, DIFFERENT AS SHOWN)

REV	DATE	MODIFICATION DESCRIPTION	CHANGE	OPERATION	DRAW	DATE	SCALE	FIT	PART NO.
AO	2021/10/20	NEW	Ken	x.x ±0.40	Ken	2021/10/20	UNIT	mm	3601-SXXX-DX1MXXXX1
				x.xx ±0.25	CHECK	DATE	SIZE	A4	TITLE:
				x.xxx ±0.15	APPROVE	DATE	SHEET	3/8	1.27mm BTB Female Header W=3.05, -SN STYLE, SMT
				Angle ± 3°			PROJ.	⌀	Customer NO.
				DIM TOL					

WCON
Http: www.wcon.com

WCON-Dongguan Tel: +86 769 85358920
WCON-Kunshan Tel: +86 512 57468408
Fax: +86 769 85358915 Fax: +86 512 57468468
E-mail: sales@wcon.com E-mail: salesks@wcon.com

TABLE 4

No.	Pin Number (Per Row)	POLARIZATION	BUMP LOCKING A	BUMP LOCKING B	BUMP LOCKING C
4	2*5,2*7,2*8	NO	YES	NO	NO
3	2*10-2*24	YES	YES	NO	NO
3	2*25-2*34	YES	YES	YES	NO
3	2*35-2*50	YES	YES	YES	YES
2	ALL	NO	NO	NO	NO
1	2*5-2*50	YES	NO	NO	NO

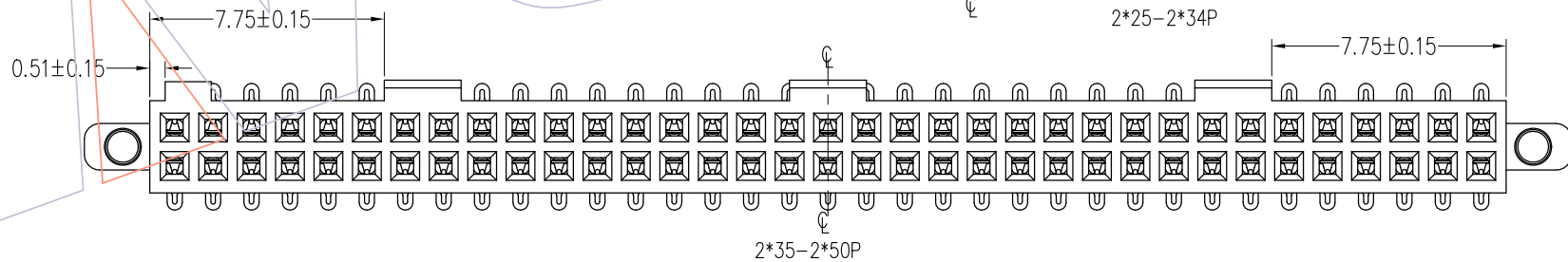
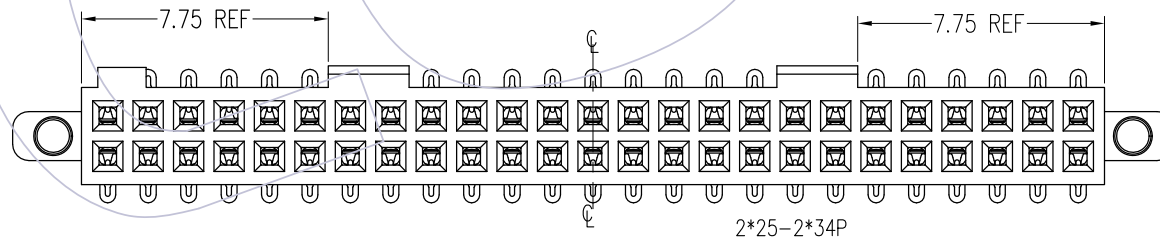
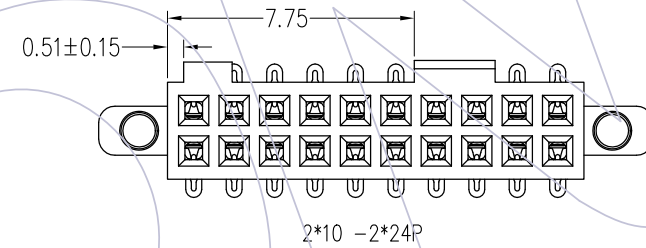
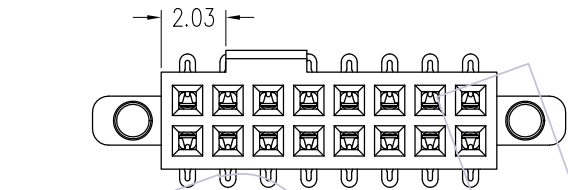
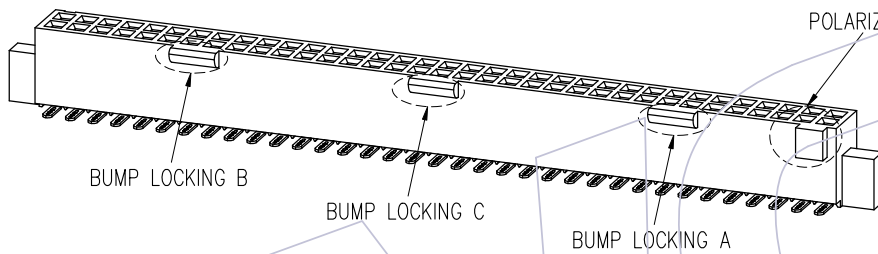

REV	DATE	MODIFICATION DESCRIPTION	CHANGE	OPERATION	DRAW	DATE	SCALE	FIT	PART NO.
AO	2021/10/20	NEW	Ken	x.x ±0.40	Ken	2021/10/20	UNIT	mm	3601-SXXX-DX1MXXXX1
				x.xx ±0.25	CHECK	DATE	SIZE	A4	TITLE:
				x.xxx ±0.15	APPROVE	DATE	SHEET	4/8	1.27mm BTB Female Header W=3.05, -SN STYLE, SMT
				Angle ± 3°			PROJ.	Customer NO.	
				DIM TOL					

WCON
Http: www.wcon.com

WCON-Dongguan
Tel: +86 769 85358920
Fax: +86 769 85358915
E-mail: sales@wcon.com

WCON-Kunshan
Tel: +86 512 57468408
Fax: +86 512 57468468
E-mail: salesks@wcon.com

HSF

Ordering Information

3601 - S XXX -D X1M XX X X1

No.Of Pins:
04-100Pin
(See Table 5)

Housing Character:
1= Notch+No Bump Locking
2= No Notch+No Bump Locking
3= Notch+ Bump Locking
4= No Notch + Bump Locking
(SEE TABLE 4)



Internal Code:
0= Weld Tab,
Tail Length= 2.07mm
1= Weld Tab,
Tail Length= 2.93mm
(See Table 1)

Packaging :
R=Tape & Reel+ Cap
T=Tube
P=Tube + Cap

Contact Plating:
W1=3u" Gold/Matte Tin,
W2=5u" Gold/Matte Tin,
W3=10u" Gold/Matte Tin,
W4=15u" Gold/Matte Tin,
W5=30u" Gold/Matte Tin,

TABLE 5:

PIN No.(HOUSING WITH LOCKING)	PIN No.(HOUSING WITHOUT LOCKING)	Part Number	DIM.A	DIM.B	DIM.E	DIM.K
NA	4(2*2P)	3601-S004-DX1MXXX1	2.92	1.27	4.70	7.24
NA	6(2*3P)	3601-S006-DX1MXXX1	4.19	2.54	5.97	8.51
NA	8(2*4P)	3601-S008-DX1MXXX1	5.46	3.81	7.24	9.78
10(2*5P)	10(2*5P)	3601-S010-DX1MXXX1	6.73	5.08	8.51	11.05
NA	12(2*6P)	3601-S012-DX1MXXX1	8.00	6.35	9.87	12.32
14(2*7P)	14(2*7P)	3601-S014-DX1MXXX1	9.27	7.62	11.05	13.59
16(2*8P)	16(2*8P)	3601-S016-DX1MXXX1	10.54	8.89	12.32	14.86
20(2*10P)	20(2*10P)	3601-S020-DX1MXXX1	13.08	11.43	14.86	17.40
30(2*15P)	30(2*15P)	3601-S030-DX1MXXX1	19.43	17.78	21.21	23.75
40(2*20P)	40(2*20P)	3601-S040-DX1MXXX1	25.78	24.13	27.56	30.10
50(2*25P)	50(2*25P)	3601-S050-DX1MXXX1	32.13	30.48	33.91	36.45
60(2*30P)	60(2*30P)	3601-S060-DX1MXXX1	38.48	36.83	40.26	42.80
70(2*35P)	70(2*35P)	3601-S070-DX1MXXX1	44.83	43.18	46.61	49.15
80(2*40P)	80(2*40P)	3601-S080-DX1MXXX1	51.18	49.53	52.96	55.50
90(2*45P)	90(2*45P)	3601-S090-DX1MXXX1	57.53	55.88	59.31	61.85
100(2*50P)	100(2*50P)	3601-S100-DX1MXXX1	63.88	62.23	65.66	68.20

REV	DATE	MODIFICATION DESCRIPTION	CHANGE	OPERATION		DRAW Ken	DATE 2021/10/20	SCALE UNIT	FIT mm	PART NO. 3601-SXXX-DX1MXXX1	TITLE: 1.27mm BTB Female Header W=3.05, -SN STYLE, SMT	 Http: www.wcon.com WCON-Dongguan Tel: +86 769 85358920 WCON-Kunshan Tel: +86 512 57468408 Fax: +86 769 85358915 E-mail: sales@wcon.com	
				x.x	±0.40								
AO	2021/10/20	NEW	Ken	x.xx	±0.25	CHECK	DATE	SIZE	A4	Customer NO.			
				x.xxx	±0.15	APPROVE	DATE	SHEET	5/8				
				Angle	± 3'			PROJ.					
				DIM	TOL								

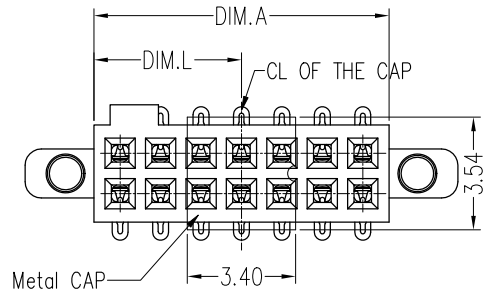

Housing Character	PIN No.	DIM.L
No Notch+No Bump Locking	2*2P~2*7P	DIM.L=1/2*DIM.A
Notch+No Bump Locking	2*5P	DIM.L=3.73
	2*6P~2*7P	DIM.L=1/2*DIM.A

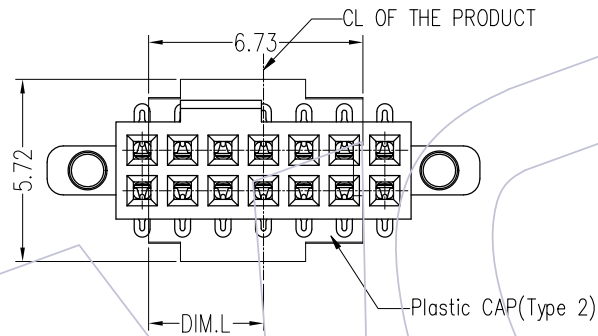

Housing Character	PIN No.	DIM.L
No Notch + Bump Locking	2*5P	DIM.L=3.37
	2*7P	DIM.L=3.61
	2*8P	DIM.L=4.24
Notch+ Bump Locking	2*35~2*50P	DIM.L=2.97

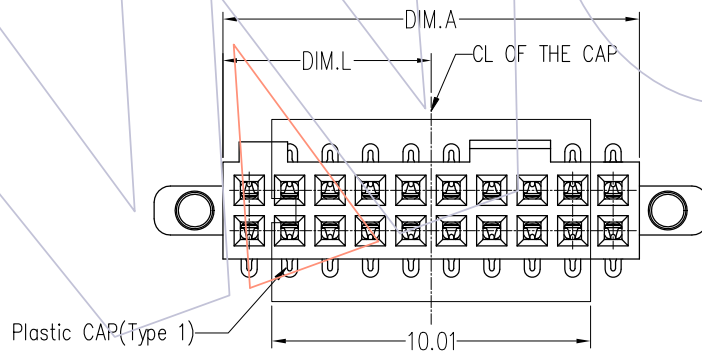

Housing Character	PIN No.	DIM.L
No Notch+No Bump Locking	2*8P~2*50P	DIM.L=1/2*DIM.A
Notch+No Bump Locking	2*8P~2*50P	DIM.L=1/2*DIM.A
Notch+ Bump Locking	2*10P~2*13P	DIM.L=6.48
	2*14P~2*17P	DIM.L=11.56
	2*18P~2*34P	DIM.L=1/2*DIM.A

REV	DATE	MODIFICATION DESCRIPTION	CHANGE	OPERATION	DRAW	DATE	SCALE	FIT	PART NO.
AO	2021/10/20	NEW	Ken	x.x ±0.40	Ken	2021/10/20	UNIT	mm	3601-SXXX-DX1MXXXX1
				x.xx ±0.25	CHECK	DATE	SIZE	A4	TITLE:
				x.xxx ±0.15	APPROVE	DATE	SHEET	6/8	1.27mm BTB Female Header W=3.05, -SN STYLE, SMT
				Angle ± 3°			PROJ.	Customer NO.	
				DIM TOL					

WCON

Http: www.wcon.com

WCON-Dongguan Tel: +86 769 85358920 Fax: +86 769 85358915 E-mail: sales@wcon.com	WCON-Kunshan Tel: +86 512 57468408 Fax: +86 512 57468468 E-mail: salesks@wcon.com
---	--

HSF

TABLE 5:

		ASS'Y HIGH(H)		MALE	FEMALE	WIPE	
		3601-SM LEAD STYLE				FULLY MATED	MIN @ H MAX
		-02					
		FULLY MATED	MAX				
3601-PS LEAD STYLE	-01	6.15	6.60	5.59	4.83	0.84	0.38
	-03	6.15	6.60	5.59	4.83	0.84	0.38
	-11	7.93	8.31	7.37	4.83	0.84	0.38
	-13	7.93	8.31	7.37	4.83	0.84	0.38
	-21	9.70	10.15	9.14	4.83	0.84	0.38
	-23	9.70	10.15	9.14	4.83	0.84	0.38
	-31	11.61	12.06	11.05	4.83	0.84	0.38

TABLE 6:

		ASS'Y HIGH(H)		MALE	FEMALE	WIPE	
		3601-SM LEAD STYLE				FULLY MATED	MIN @ H MAX
		-02					
		FULLY MATED	MAX				
3601-PM LEAD STYLE	-02	6.30	6.76	5.74	4.83	0.84	0.38
	-12	8.08	8.54	7.52	4.83	0.84	0.38
	-22	9.86	10.32	9.30	4.83	0.84	0.38
	-32	11.76	12.22	11.20	4.83	0.84	0.38

TABLE 7:

		ASS'Y HIGH(H)		MALE	FEMALE	WIPE	
		3601-SM LEAD STYLE				FULLY MATED	MIN @ H MAX
		-02					
		FULLY MATED	MAX				
3601-PR LEAD STYLE	-01-RA	6.15	6.60	5.59	4.83	0.84	0.38

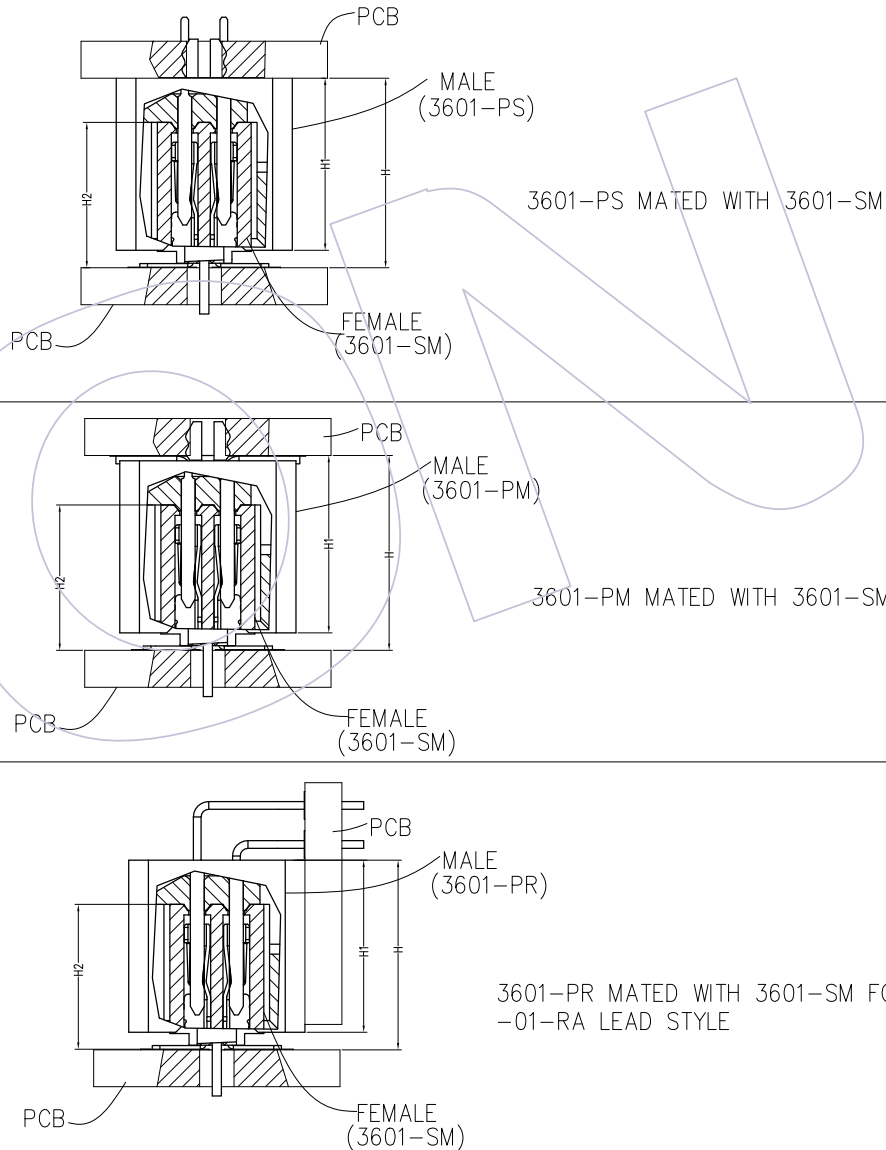



REV	DATE	MODIFICATION DESCRIPTION	CHANGE	OPERATION		DRAW Ken	DATE 2021/10/20	SCALE UNIT	FIT mm	PART NO. 3601-SXXX-DX1MXXXX1
				X.X	±0.40					
				X.XX	±0.25	CHECK	DATE			TITLE: 1.27mm BTB Female Header W=3.05, -SN STYLE, SMT
				X.XXX	±0.15	APPROVE	DATE			Customer NO.
				Angle	± 3'					
				DIM	TOL					

WCON
Http: www.wcon.com

WCON-Dongguan Tel: +86 769 85358920 Fax: +86 769 85358915 E-mail: sales@wcon.com	WCON-Kunshan Tel: +86 512 57468408 Fax: +86 512 57468468 E-mail: salesks@wcon.com
---	--

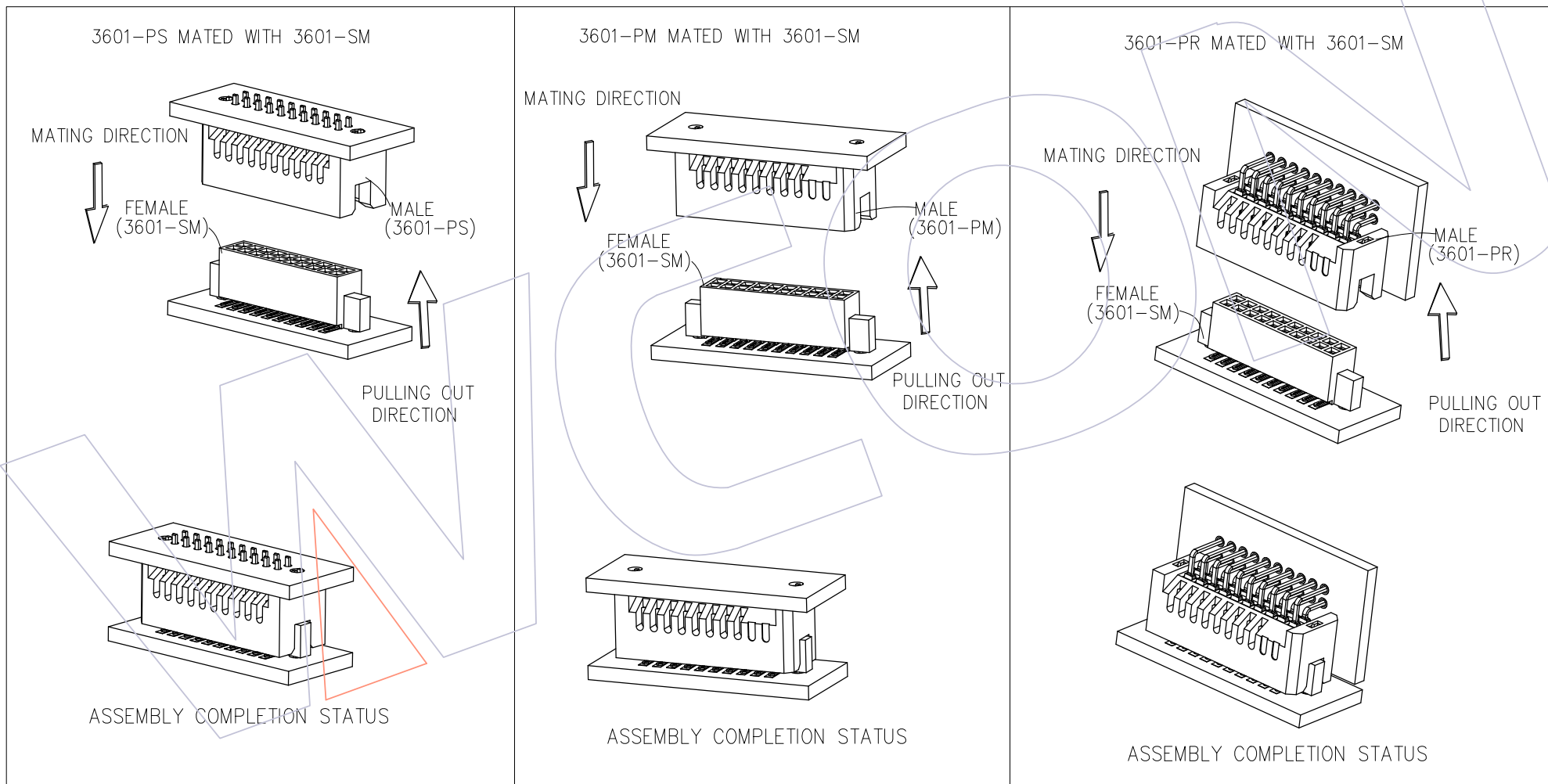
DYNAMIC USE HINT:



				OPERATION	DRAW	DATE	SCALE	FIT	PART NO.	 Http: www.wcon.com
				X.X ±0.40	Ken	2021/10/20	UNIT	mm	3601-SXXX-DX1MXXX1	
				X.XX ±0.25	CHECK	DATE	SIZE	A4	TITLE:	
				X.XXX ±0.15	APPROVE	DATE	SHEET	8/8	1.27mm BTB Female Header W=3.05, -SN STYLE, SMT	
AO	2021/10/20	NEW	Ken	Angle ± 3'			PROJ.	⌀	Customer NO.	WCON-Dongguan Tel: +86 769 85358920 Fax: +86 769 85358915 E-mail: sales@wcon.com
REV	DATE	MODIFICATION DESCRIPTION	CHANGE	DIM TOL						WCON-Kunshan Tel: +86 512 57468408 Fax: +86 512 57468468 E-mail: salesks@wcon.com