

HSF

Current Rating: 3.0A
 Voltage Rating: 32V
 Insulation Resistance: 1000MΩ min 500V DC
 Withstanding Voltage: 1000V
 Operation Temperature: -20°C to +85°C
 Insulation
 Material: LCP
 Flammability: UL94V-0
 Color: Black
 Contact:
 Material: Copper Alloy
 Plating:
 Underplating: 100u" Nickel
 Wiping Area: Gold with Lubricant
 Solder Tails: Gold Flash
 Solder Tabs: 120u" Matte Sn
 over 40-120u" Nickel

Locating Posts

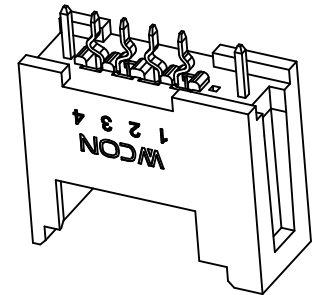
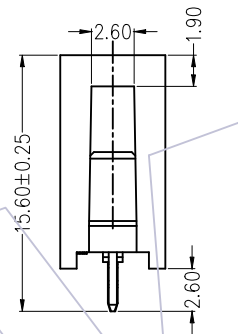
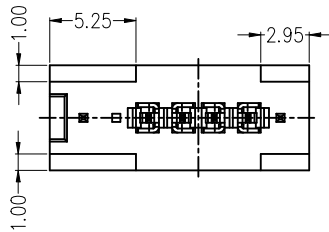
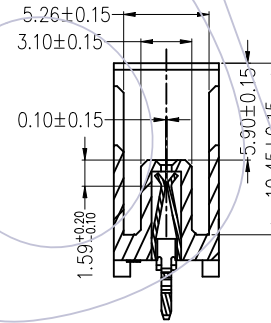
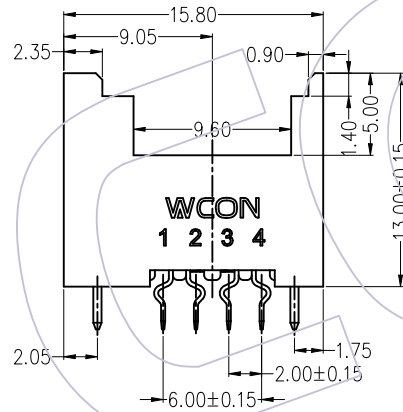
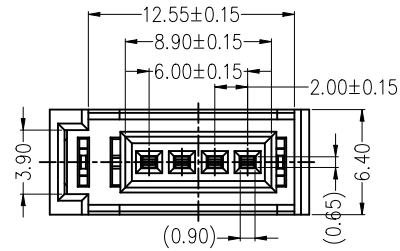
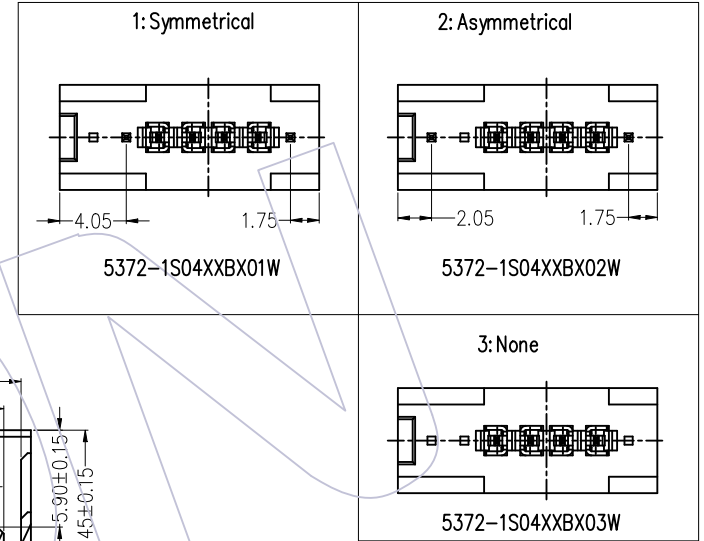

Ordering Information

5372 - 1 X 04 XX X X XX X

SINGLE ROW

Type
 M=180° SMT
 R=90° Dip
 S=180° Dip
 Z=90° SMT

Pin
 04=4P

Color
 B=BLACK
 N=NATURAL

Terminal Plating
 S0=Gold Flash/Tin
 S1=3u"Gold/Tin
 S2=5u"Gold/Tin
 S3=10u"Gold/Tin
 S4=15u"Gold/Tin
 S5=30u"Gold/Tin

Packing
 T=Tube
 R=Tape&Reel
 A=Tray
 O=PE Bag

LOGO
 NA
 W=With WCON LOGO
 M=Customer'S LOGO

Series No. SPC.
 (01-99)

Locating Posts
 1=Symmetrical
 2=Asymmetrical
 3=None

REV	DATE	MODIFICATION DESCRIPTION	CHANGE	OPERATION	DRAW	DATE	SCALE	FIT	PART NO.
A0	2020/12/01	NEW	Kair	X.X ±0.40	Kair	2020/12/01	UNIT	mm	5372-1S04XXBX0XW
				X.XX ±0.25	CHECK	DATE	inch	SIZE	
				X.XXX ±0.15	APPROVE	DATE	SHEET	A4	TITLE:
				Angle ± 3°			1/2		2.0mm Mini Clamp Socket 4p Single Row Through Hole Type
				DIM TOL			PROJ.		Customer NO.

WCON

Http: www.wcon.com

WCON-Dongguan
 Tel: +86 769 85358920
 Fax: +86 769 85358915
 E-mail: sales@wcon.com

WCON-Kunshan
 Tel: +86 512 57468408
 Fax: +86 512 57468468
 E-mail: salesks@wcon.com

HSF

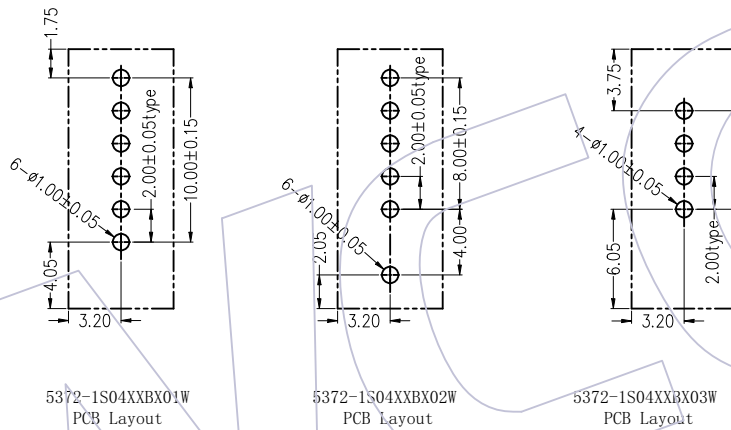

Recommended Hole Pattern

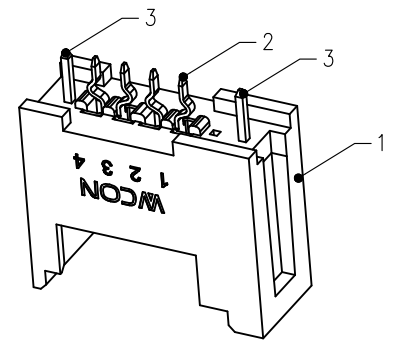
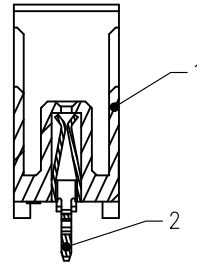

3	Dip-Tab	M5372-BXXS05	C2680	2
2	Contact	T5372-PXXS04	C5191R-H	4
1	Housing	G5372-1S03B01W	LCP	1
No.	Part Name	Part No.	Material	Q'TY

REV	DATE	MODIFICATION DESCRIPTION	CHANGE	OPERATION	DRAW	DATE	SCALE	FIT	PART NO.
A0	2020/12/01	NEW	Kair	X.X ±0.40	Kair	2020/12/01	UNIT	mm inch	5372-1S04XXBX0XW
				X.XX ±0.25	CHECK	DATE	SIZE	A4	
				X.XXX ±0.15	APPROVE	DATE	SHEET	2/2	TITLE: 2.0mm Mini Clamp Socket 4p Single Row Through Hole Type
				Angle ± 3°			PROJ.	⌀	Customer NO.
				DIM TOL					

WCON
 Http: www.wcon.com
 WCON-Dongguan Tel: +86 769 85358920
 WCON-Kunshan Tel: +86 512 57468408
 Fax: +86 769 85358915 Fax: +86 512 57468468
 E-mail: sales@wcon.com E-mail: salesks@wcon.com