

HSF

NOTES:

Current Rating: 10A
 Voltage Rating: 300V
 Contact Resistance: 8milliohm Max
 Withstand Voltage: AC2000V
 Insulation Resistance: 1000Megohm Min
 Screw Torque: 4.4 lbf.in
 Wire range: 12-30AWG
 Operation Temperature: -40°C to +105°C

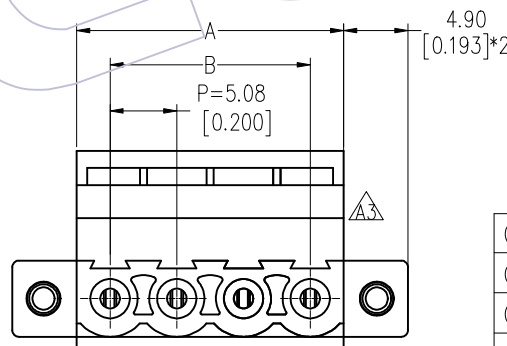
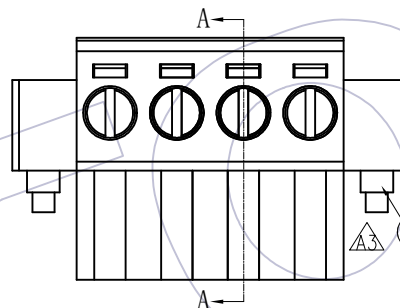
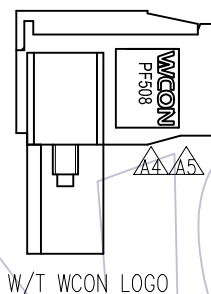
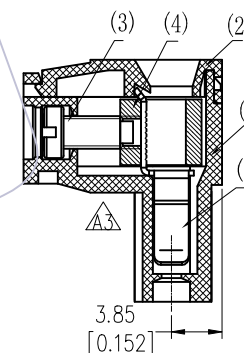
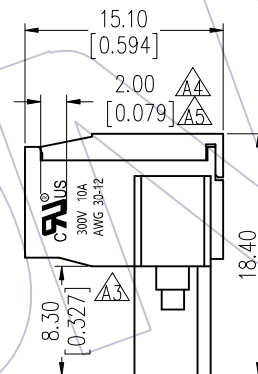
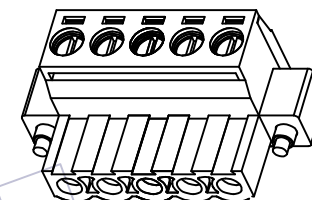
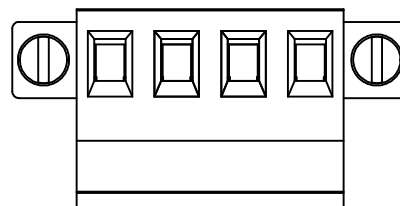
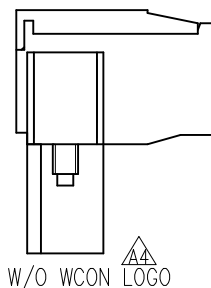

Ordering Information:

P F 508- C XX A SM W 1 N

F=Female Pitch No.of Pins Contact Plated Blank=W/T WCON Logo
 508=5.08 02-24P SM=Matte Tin N=W/O WCON Logo
 Color Type
 A=Green W=With Screw

13P	66.04 ± 0.30	60.96 ± 0.30			
12P	60.96 ± 0.30	55.88 ± 0.30	24P	121.92 ± 0.50	116.84 ± 0.50
11P	55.88 ± 0.30	50.80 ± 0.30	23P	116.84 ± 0.50	111.76 ± 0.50
10P	50.80 ± 0.30	45.72 ± 0.30	22P	111.76 ± 0.50	106.68 ± 0.50
9P	45.72 ± 0.30	40.64 ± 0.30	21P	106.68 ± 0.50	101.60 ± 0.50
8P	40.64 ± 0.30	35.56 ± 0.30	20P	101.60 ± 0.50	96.52 ± 0.50
7P	35.56 ± 0.20	30.48 ± 0.20	19P	96.52 ± 0.40	91.44 ± 0.40
6P	30.48 ± 0.20	25.40 ± 0.20	18P	91.44 ± 0.40	86.36 ± 0.40
5P	25.40 ± 0.20	20.32 ± 0.20	17P	86.36 ± 0.40	81.28 ± 0.40
4P	20.32 ± 0.20	15.24 ± 0.20	16P	81.28 ± 0.40	76.20 ± 0.40
3P	15.24 ± 0.20	10.16 ± 0.20	15P	76.20 ± 0.40	71.12 ± 0.40
2P	10.16 ± 0.20	5.08 ± 0.10	14P	71.12 ± 0.40	66.04 ± 0.40
PIN	A	B	PIN	A	B

ITEM	品名	料号	数量	材料
(6)	Screw-2	MC025-1SZC01	2	C1018
(5)	Contact	TPT051-PSM002	N	C5191R-H T=0.4mm
(4)	Pin Block	BL025-1SN101	N	C3604
(3)	Screw	MA025-1SXX01	N	C1018
(2)	Cover	XPC508-XXB1XN1	1	PA66 UL94-V0
(1)	Housing	XPF508-XXB1XW1(N)	1	PA66 UL94-V0

REV	DATE	MODIFICATION DESCRIPTION	CHANGE	OPERATION	DRAW	DATE	SCALE	FIT	PART NO.
A5	2022/03/23	Modify LOGO	△A5	XSR	OPERATION	2022/03/23	UNIT	mm	PF508-CXXASMW1(N) △A1 △A4
A4	2020/08/03	ADD LOGO; ADD W/O LOGO P/N	△A4	XSR	±0.40		SIZE	A4	TITLE: 5.08mm Pitch Female Pluggable Terminal Blocks
A3	2015/12/15	Modify	△A3		±0.25		SHEET	1/1	Customer NO.
A0	2011/06/08	NEW			±0.15		PROJ.	◆	
				Angle	± 3°				
				DIM	TOL				

WCON

Http: www.wcon.com

WCON-Dongguan Tel: +86 769 85358920 Fax: +86 769 85358915 E-mail: sales@wcon.com
 WCON-Kunshan Tel: +86 512 57468408 Fax: +86 512 57468468 E-mail: salesks@wcon.com