

HSF

NOTES:

Current Rating:0.5A/Contact
 Voltage Rating:250V AC
 Contact Resistance:35milliohm Max
 Withstand Voltage:500V AC/DC
 Insulation Resistance:500Megohm Min
 Operation Temperature:-20°C to +105°C

Housing Material:PBT+30%GF(UL94V-0)
 Cover Material:PBT+30%GF(UL94V-0)
 Terminal Material:Phosphor Bronze
 Holding pin Material:Phosphor Bronze
 Terminal plating:Sn-Au over Ni Plating
 Holding pin plating:Sn over Ni Plating

Ordering Information

6325D-XXX SD XX P X X 0 X

No.of Pins	Contact Plating	Type	Packing
	S1=3u"Gold/Tin W:With Board Lock		T=Tube
	S2=5u"Gold/Tin N:Without Board Lock		

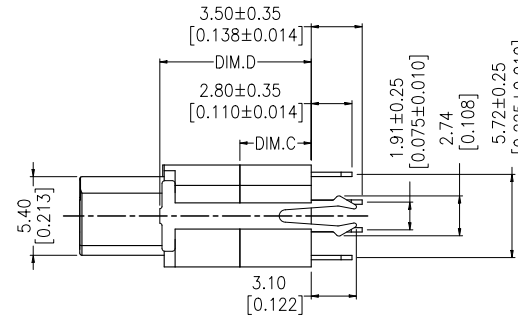
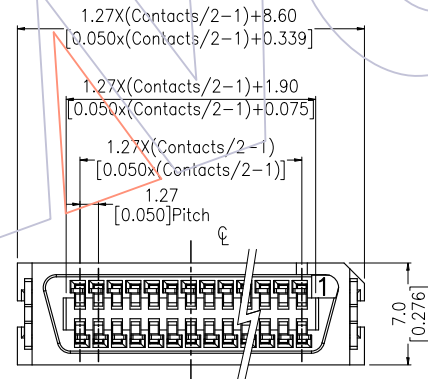
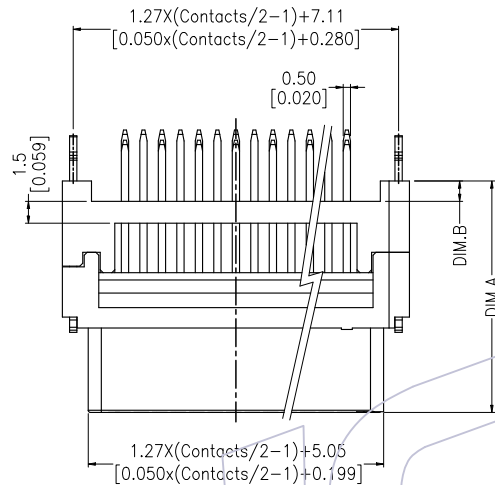

With Board Lock

Recommended P.C.B Layout (Top Side)

(PCB BOARD TOLERANCE±0.05)

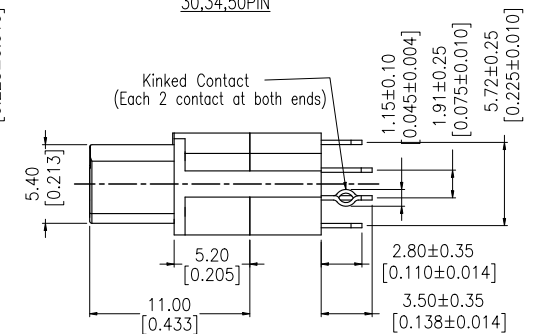
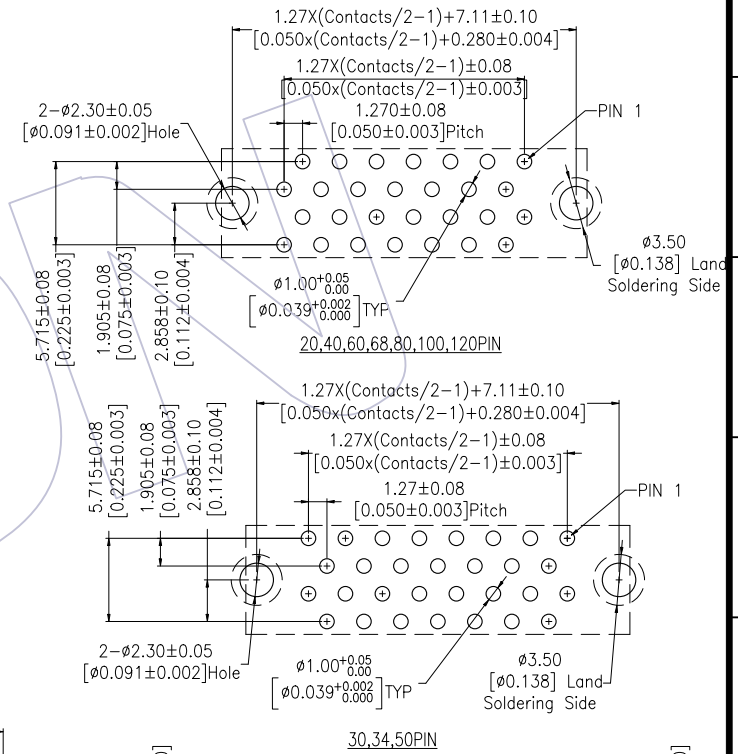

Without Board Lock

OPERATION	DRAW	DATE	SCALE	Fit	PART NO.
X.X ±0.40	Tsinsn	2013/02/07	UNIT	mm	6325D-XXXDXXPXX0X
X.XX ±0.25	CHECK	DATE	SIZE	A4	TITLE:
X.XXX ±0.15	APPROVE	DATE	SHEET	1/2	1.27mm SCSI D-Type Female 180° DIP Add Cover
Angle ± 3'			PROJ.		Customer NO.
DIM	TOL				

WCON
 Http: www.wcon.com

WCON-Dongguan	WCON-Kunshan
Tel: +86 769 85358920	Tel: +86 512 57468408
Fax: +86 769 85358915	Fax: +86 512 57468468
E-mail: sales@wcon.com	E-mail: salesks@wcon.com

HSF

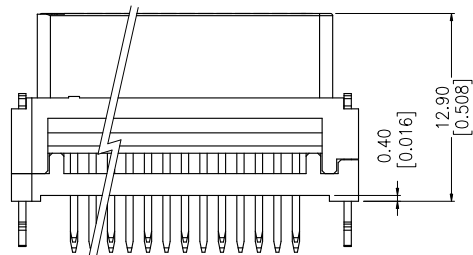

6325D-XXXSDXXPXX01

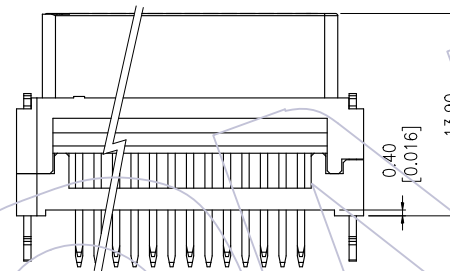
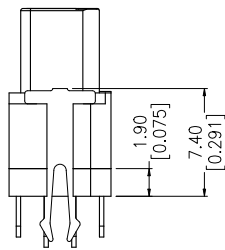

6325D-XXXSDXXPXX02

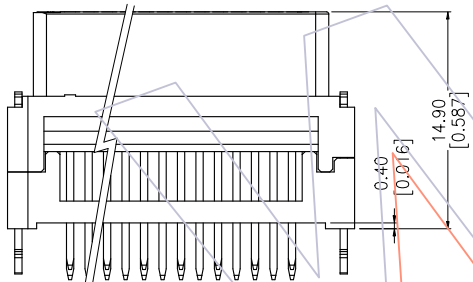
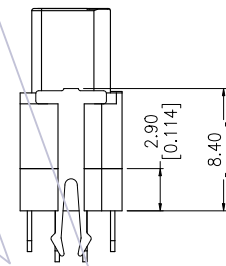

6325D-XXXSDXXPXX03

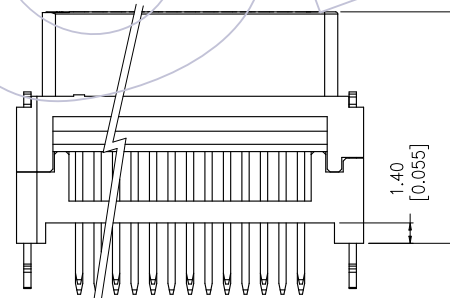
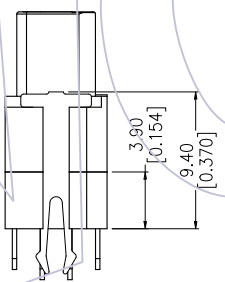

6325D-XXXSDXXPXX04

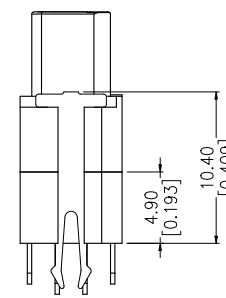

PART NO.	DIM.A	DIM.B	DIM.C	DIM.D
6325D-XXXSDXXPXX01	12.90	0.40	1.90	7.40
6325D-XXXSDXXPXX02	13.90	0.40	2.90	8.40
6325D-XXXSDXXPXX03	14.90	0.40	3.90	9.40
6325D-XXXSDXXPXX04	15.90	1.40	4.90	10.40

REV	DATE	MODIFICATION DESCRIPTION	CHANGE	OPERATION	DRAW	DATE	SCALE	Fit	PART NO.
A0	2013/02/07	NEW	-----	X.X ±0.40	Tsinsn	2013/02/07	UNIT	mm	6325D-XXXSDXXPXX0X
				X.XX ±0.25	CHECK	DATE	SIZE	inch	TITLE:
				X.XXX ±0.15	APPROVE	DATE	SHEET	A4	1.27mm SCSI D-Type
				Angle ± 3'			PROJ.	2/2	Female 180° DIP Add Cover
				DIM TOL					Customer NO.

WCON

Http: www.wcon.com

WCON-Dongguan	WCON-Kunshan
Tel: +86 769 85358920	Tel: +86 512 57468408
Fax: +86 769 85358915	Fax: +86 512 57468468
E-mail: sales@wcon.com	E-mail: salesks@wcon.com