

# HSF

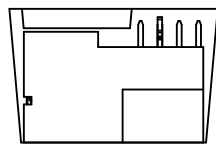

产品放置示意图

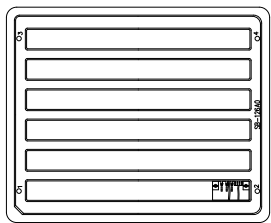

No. 1  
产品装入真空盒内,  
真空盒规格:SB-126AB(330\*270\*19.6mm)

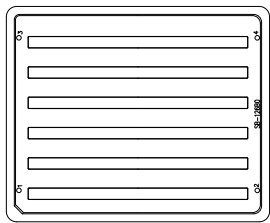
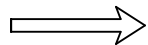

No. 2  
盖上盒盖

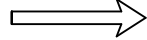

料号	
品名	
数量	
日期	

数量标签

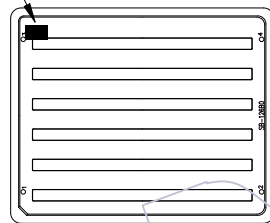

No. 3  
贴标签于真空盒左上角



缠PE膜

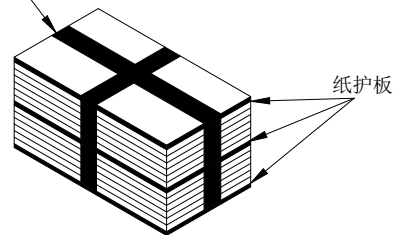

No. 4  
12盒为一扎,上下各放一块纸护板  
中间再加一块纸护板,再用PE膜缠绕成十字形

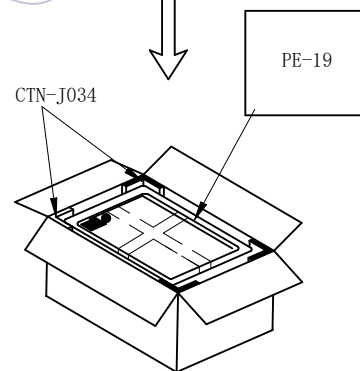

No. 5

纸箱内需套防水袋PE-19,再将真空盒装入纸箱,1扎/箱  
加一包干燥剂后密封,四周各放置一个纸护角  
纸箱规格:CTN-70A(35\*30\*26cm)

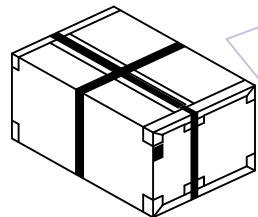

No. 7  
打包装带

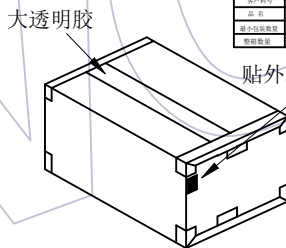

No. 6  
封箱及贴标签于纸箱侧面的左上角

WCON 康唯电子有限公司		3
WCON#		HSF
客户料号		
品名		
基本包装数量		P35
数量单位		PCS

大透明胶

贴外箱标签

## 说明:

1. 产品如图所示型态放入真空盒
2. 注意各标签样式、位置及方向的一致性;
3. 打外箱包装带时需注意, 打为十字型。

变更记事

						零件图	颜色		SCALE	fit	<b>WCON</b>	WCON ELECTRONICS (GUANGDONG) CO., LTD
						X. ±0.50	COLOR		UNIT	mm		
						X.X ±0.20	材质		SIZE	A4	料号 PART NO.	P3MRA-XX-XXXXXXXXXX
						X.XX ±0.10	设计	苏珊	2021/11/11	SHEET	品名 TITLE:	PSP Conn. Type 3 Spacing A R/A Male
						X.XXX ±0.05	审核			PROJ.		DIP=3.43 W/T LOCK 包装规范
A0	2021/11/11	NEW				Angle	CHECK					
版次	日期	变更说明	变更	核准		X. ± 2°	核准					
REV	DATE	MODIFICATION DESCRIPTION	CHANGE	APPROVE		DIM TOL	APPROVE					

# HSF

No.	P/N	DIM "A"	PCS/Tray	PCS/箱	No.	P/N	DIM "A"	PCS/Tray	PCS/箱
1	P3MRA-20-020XXXXXXAX	156.21	6	72	33	P3MRA-06-024XXXXXXAX	69.85	18	216
2	P3MRA-20-012XXXXXXAX	151.13	6	72	34	P3MRA-06-020XXXXXXAX	67.31	24	288
3	P3MRA-14-024XXXXXXAX	120.65	12	144	35	P3MRA-06-016XXXXXXAX	64.77	24	288
4	P3MRA-14-012XXXXXXAX	113.03	12	144	36	P3MRA-06-012XXXXXXAX	62.23	24	288
5	P3MRA-13-012XXXXXXAX	106.68	12	144	37	P3MRA-06-008XXXXXXAX	59.69	24	288
6	P3MRA-12-024XXXXXXAX	107.95	12	144	38	P3MRA-05-024XXXXXXAX	63.50	24	288
7	P3MRA-12-020XXXXXXAX	105.41	12	144	39	P3MRA-05-008XXXXXXAX	53.34	30	360
8	P3MRA-12-012XXXXXXAX	100.33	12	144	40	P3MRA-04-120XXXXXXAX	118.11	12	144
9	P3MRA-11-032XXXXXXAX	106.68	12	144	41	P3MRA-04-060XXXXXXAX	80.01	18	216
10	P3MRA-11-024XXXXXXAX	101.60	12	144	42	P3MRA-04-048XXXXXXAX	72.39	18	216
11	P3MRA-10-028XXXXXXAX	97.79	12	144	43	P3MRA-04-032XXXXXXAX	62.23	24	288
12	P3MRA-10-024XXXXXXAX	95.25	12	144	44	P3MRA-04-024XXXXXXAX	57.15	24	288
13	P3MRA-10-020XXXXXXAX	92.71	18	216	45	P3MRA-04-020XXXXXXAX	54.61	30	360
14	P3MRA-10-016XXXXXXAX	90.17	18	216	46	P3MRA-04-016XXXXXXAX	52.07	30	360
15	P3MRA-10-008XXXXXXAX	85.09	18	216	47	P3MRA-04-012XXXXXXAX	49.53	30	360
16	P3MRA-09-024XXXXXXAX	88.90	18	216	48	P3MRA-04-008XXXXXXAX	46.99	30	360
17	P3MRA-09-020XXXXXXAX	86.36	18	216	49	P3MRA-03-032XXXXXXAX	55.88	24	288
18	P3MRA-09-016XXXXXXAX	83.82	18	216	50	P3MRA-03-024XXXXXXAX	50.80	30	360
19	P3MRA-09-012XXXXXXAX	81.28	18	216	51	P3MRA-03-016XXXXXXAX	45.72	36	432
20	P3MRA-08-028XXXXXXAX	85.09	18	216	52	P3MRA-02-144XXXXXXAX	120.65	12	144
21	P3MRA-08-024XXXXXXAX	82.55	18	216	53	P3MRA-02-076XXXXXXAX	77.47	18	216
22	P3MRA-08-016XXXXXXAX	77.47	18	216	54	P3MRA-02-048XXXXXXAX	59.69	24	288
23	P3MRA-08-012XXXXXXAX	74.93	18	216	55	P3MRA-02-040XXXXXXAX	54.61	30	360
24	P3MRA-08-008XXXXXXAX	72.39	18	216	56	P3MRA-02-036XXXXXXAX	52.07	30	360
25	P3MRA-07-040XXXXXXAX	86.36	18	216	57	P3MRA-02-032XXXXXXAX	49.53	30	360
26	P3MRA-07-024XXXXXXAX	76.20	18	216	58	P3MRA-02-024XXXXXXAX	44.45	36	432
27	P3MRA-07-016XXXXXXAX	71.12	18	216	59	P3MRA-02-020XXXXXXAX	41.91	36	432
28	P3MRA-06-104XXXXXXAX	120.65	12	144	60	P3MRA-02-016XXXXXXAX	39.37	42	504
29	P3MRA-06-060XXXXXXAX	92.71	18	216	61	P3MRA-02-012XXXXXXAX	36.83	42	504
30	P3MRA-06-040XXXXXXAX	80.01	18	216	62	P3MRA-02-008XXXXXXAX	34.29	48	576
31	P3MRA-06-036XXXXXXAX	77.47	18	216	63	P3MRA-02-004XXXXXXAX	31.75	48	576
32	P3MRA-06-032XXXXXXAX	74.93	18	216	64	P3MRA-01-036XXXXXXAX	45.72	36	432

变更记事

A0	2021/11/11	NEW	变更说明 MODIFICATION DESCRIPTION	变更 CHANGE	核准 APPROVE	零件图	颜色 COLOR	SCALE	fit	
						X.	±0.50	UNIT	mm	
						X.X	±0.20	SIZE	A4	
						X.XX	±0.10	SHEET	2/2	
						设计 DESING	苏珊	2021/11/11	PROJ.	
						审核 CHECK				
						核准 核 准				
						批准 核 准				
						DIM	TOL			



WCON ELECTRONICS (GUANGDONG) CO., LTD

料号 PART NO. P3MRA-XX-XXXXXXXXXXAX  
品名 TITLE: PSP Conn. Type 3 Spacing A R/A Male  
DIP=3.43 W/T LOCK 包装规范