

HSF

NOTES:
 Current Rating: 0.5AMP
 Voltage Rating: 50V AC/DC
 Contact Resistance: 30mΩ max
 Withstand Voltage: 100V AC for 1minute
 Insulation Resistance: 500MΩ min
 Operation Temperature: -25°C to +105°C

Housing Material: PA9T(UL94V-0), NATURAL
 Contact Material: Copper alloy
 Contact plating: Au over Ni

Ordering Information

3622-P XXX - XXX XX X 01

No. of Pins Housing High Contact Plating T=Tube
 14P 50P 023=2.30 G1=3u"Gold P=Tube+CAP
 20P 60P 028=2.80 G3=10u"Gold R=Tape&Reel
 24P 70P 033=3.30 G4=15u"Gold
 30P 80P 038=3.80 G5=30u"Gold
 32P 90P 043=4.30 H5=30u"Gold(Contact area, 3u"Gold other area)
 36P 100P 048=4.80
 40P

ASS'Y HEIGHT(K)	PLUG(H2)	SOCKET(H1)
3.00	2.33	2.20
3.50	2.80	
4.00	2.80	
4.50	3.33	
5.00	3.83	2.73
5.50	4.33	
6.00	4.83	
6.50	3.33	
7.00	3.83	
7.50	4.33	4.80
8.00	4.83	

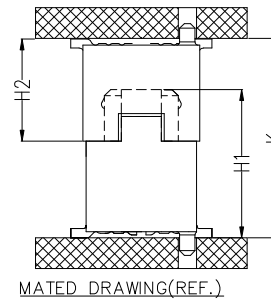
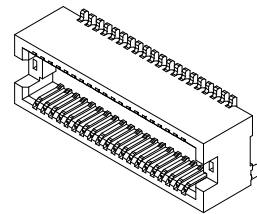
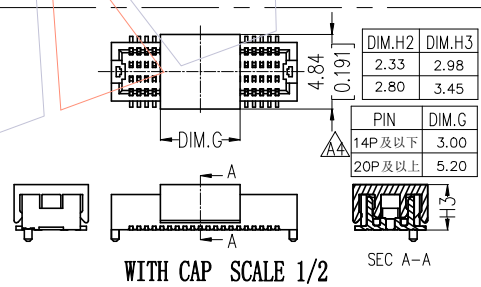

Recommended P.C.B Layout (Top Side)
 (PCB BOARD TOLERANCE ±0.05)

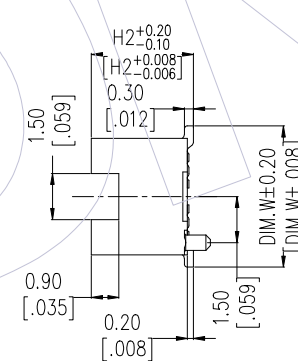
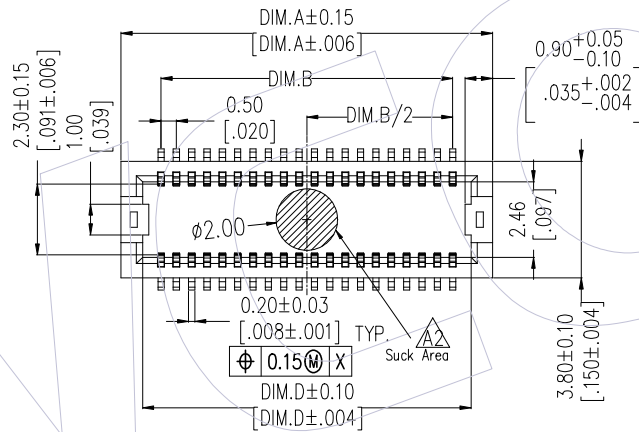
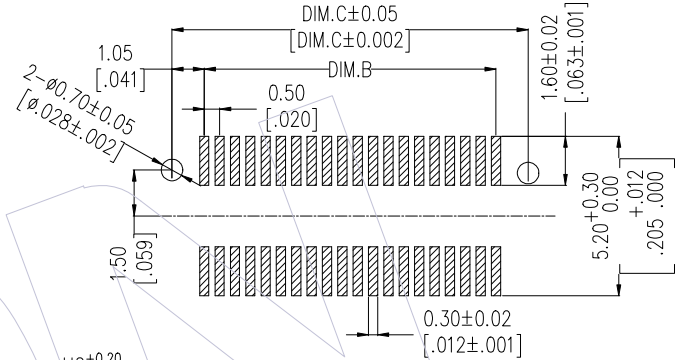
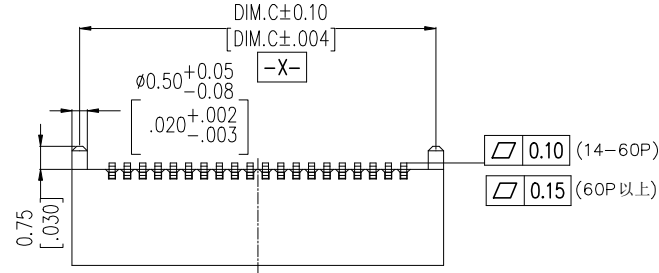

CAP	PART NO.	DIM.H2	DIM.W
WITH	3622-PXXX-023XXX01	2.33	
	3622-PXXX-028XXX01	2.80	
	3622-PXXX-033XXX01	3.33	4.60
	3622-PXXX-038XXX01	3.83	
W/O	3622-PXXX-043XXX01	4.33	
	3622-PXXX-048XXX01	4.83	

PIN	DIM.A	DIM.B	DIM.C	DIM.D
14	5.60	3.00	5.10	4.20
20	7.10	4.50	6.60	5.70
24	8.10	5.50	7.60	6.70
30	9.60	7.00	9.10	8.20
32	10.10	7.50	9.60	8.70
36	11.10	8.50	10.60	9.70
40	12.10	9.50	11.60	10.70
50	14.60	12.00	14.10	13.20
60	17.10	14.50	16.60	15.70
70	19.60	17.00	19.10	18.20
80	22.10	19.50	21.60	20.70
90	24.60	22.00	24.10	23.20
100	27.10	24.50	26.60	25.70

REV	DATE	MODIFICATION DESCRIPTION	CHANGE	DIM	TOL	APPROVE	DATE	SCALE	Fit	PART NO.	TITLE:
A4	2022/08/10	ADD 3.0 CAP	XSR	OPERATION		DRAW	2022/08/10	UNIT	mm	3622-PXXX-XXXXXX01	0.50mm BTB MALE SMT TYPE
A3	2021/07/31	ADD 70/80/90P	XSR	x.x	±0.40	CHECK		SIZE	A4		W/O LATCH
A2	2021/05/27	ADD Suck Area	XSR	x.xx	±0.25			SHEET	1/1		Customer NO.
A0	2018/02/01	NEW	-----	Angle	± 3°			PROJ.			

WCON

Http: www.wcon.com

WCON-Dongguan WCON-Kunshan
 Tel: +86 769 85358920 Tel: +86 512 57468408
 Fax: +86 769 85358915 Fax: +86 512 57468468
 E-mail: sales@wcon.com E-mail: salesks@wcon.com