

NOTES:
 Current Rating: 3.0AMP
 Contact Resistance: 20mΩ Max
 Withstand Voltage: 500V AC/DC
 Insulation Resistance: 1000MΩ Min
 Operation Temperature: -55℃ to +105℃

Contact Material: Brass
 Contact plating: Au Or Sn over Ni
 Insulator Material: PBT+30%G.F UL94V-0
 Shell: Cold Roller Steel, Ni Or Sn Plated
 Nut: Brass, Sn Over Ni Plated

Ordering Information

6222-XX F X XX B 0X

No. of Pins	Type	Contact Plating	Insulator Color
9P	Y=With Back Fork	S0=Gold Flash/Tin	B:Black
15P	B=With Back Nut	S3=10u"Gold/Tin	U:Blue
25P	F=With Front Nut	S4=15u"Gold/Tin	
37P	H=With Back Fork and Screw	S5=30u"Gold/Tin	
	N=Without Fork Without Nut		

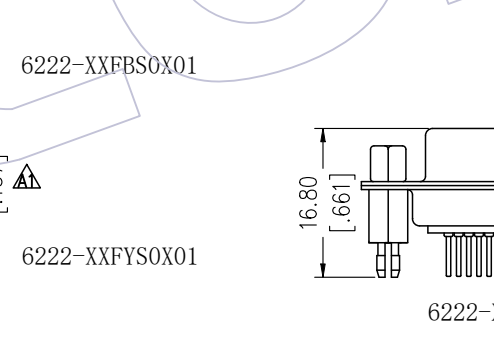
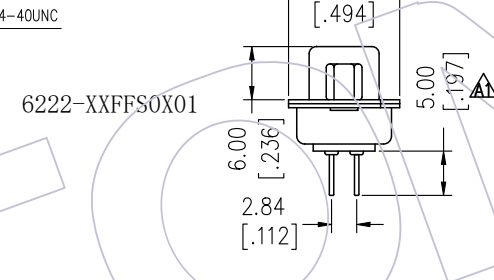
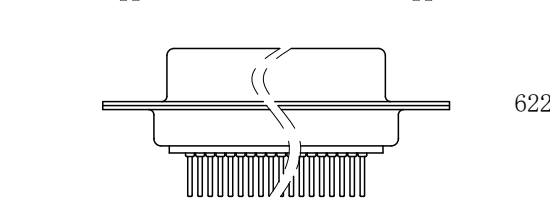
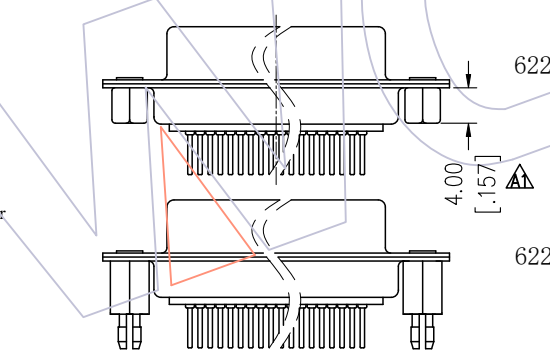
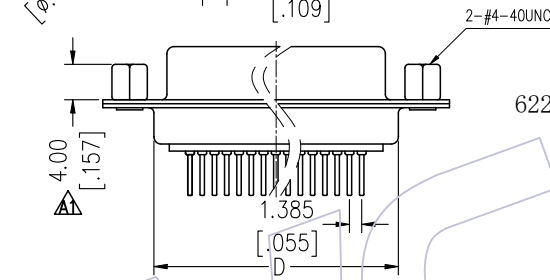
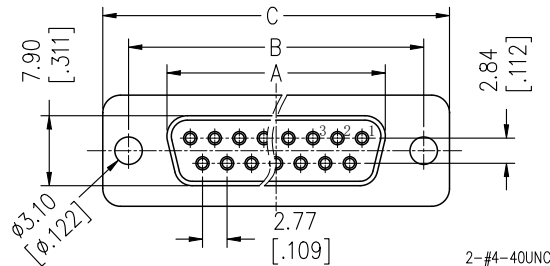

Recommended P.C.B Layout (Top Side)
 (PCB BOARD TOLERANCE ±0.05)

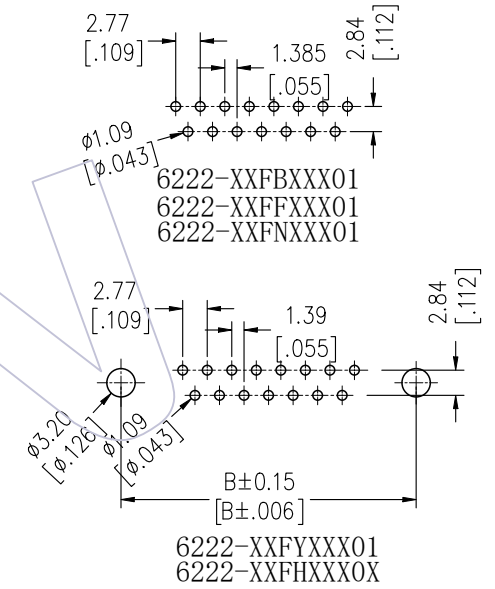

NAME	DIM "S"	
Screw	4.8 [0.189]	6.0 [0.236]

PIN	DIM "A"	DIM "B"	DIM "C"	DIM "D"
09	16.33 (0.643)	24.99 (0.984)	30.81 (1.213)	19.28 (0.759)
15	24.66 (0.971)	33.32 (1.312)	39.14 (1.541)	27.70 (1.091)
25	38.38 (1.511)	47.04 (1.852)	53.10 (2.091)	41.10 (1.618)
37	54.84 (2.159)	63.50 (2.500)	69.32 (2.729)	57.30 (2.256)

REV	DATE	MODIFICATION DESCRIPTION	CHANGE	OPERATION	DRAW	DATE	SCALE	FIT	PART NO.
A1	2019/05/15	Modify DIP	-----	x.x ±0.40	Ding	2019/05/15	UNIT	mm	6222- XXFXXX0X
A0	2012/12/04	NEW	-----	x.xx ±0.25	CHECK	DATE	SIZE	A4	TITLE:
				x.xxx ±0.15	APPROVE	DATE	SHEET	1/1	D-SUB FEMALE DUAL ROW 180° DIP
				Angle ± 3°			PROJ.	Customer NO.	
				DIM TOL					

WCON
 Http: www.wcon.com
 WCON-Dongguan Tel: +86 769 85358920
 WCON-Kunshan Tel: +86 512 57468408
 Fax: +86 769 85358915 Fax: +86 512 57468468
 E-mail: sales@wcon.com E-mail: salesks@wcon.com