

HSF

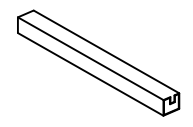

1. 27筒牛 单排,
180度 DIP



No: 1
产品装入真空管内
SG-C26 (600mm凸型真空管)

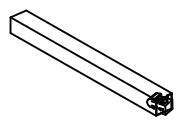

No: 2
塞塑胶塞

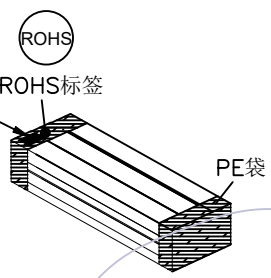

No: 3
包扎真空管及贴标签于PE袋上
(20管/扎)

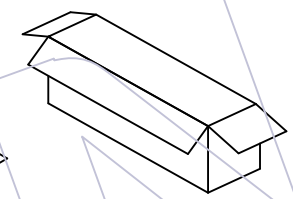

No: 4
真空管装入内箱(5扎/内箱)
内箱规格: CTN-10A(双坑A=B 63*15*15CM)

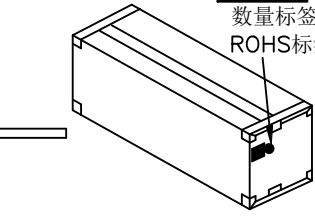
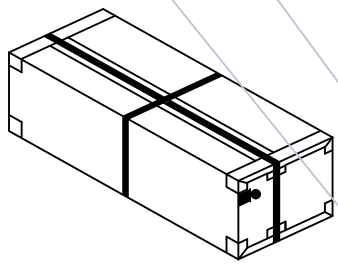

No: 5
封箱及贴标签于内箱侧面的左上角
(100管/内箱)

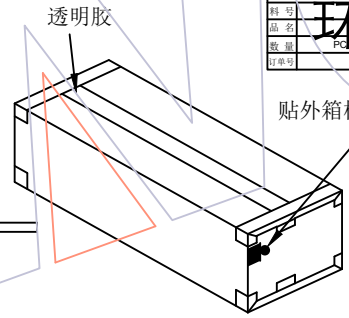

No: 6
内箱放入外箱(2内箱/外箱)
外箱规格: CTN-10C(双坑K=K 65*33*17CM)

No: 7
贴外箱标签及ROHS标签

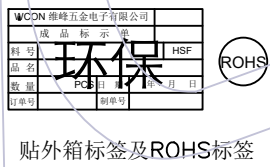

1. 27筒牛, 180度DIP, H=9.9							
规格	真空管 装数量	每内箱 装数量	每外箱 装数量	规格	真空管 装数量	每内箱 装数量	每外箱 装数量
1*8	35	3500	7000	1*32	12	1200	2400
1*10	30	3000	6000	1*34	11	1100	2200
1*14	24	2400	4800	1*40	10	1000	2000
1*16	21	2100	4200	1*44	9	900	1800
1*20	18	1800	3600	1*50	8	800	1600
1*24	15	1500	3000	1*60	7	700	1400
1*25	15	1500	3000	1*64	6	600	1200
1*26	14	1400	2800	1*80	5	500	1000
1*30	13	1300	2600	1*100	4	400	800

说明:

1. 产品如图所示型态放入真空管
2. 注意各标签样式, 位置及方向的一致性;
3. 打外箱包装带时需注意, 打为十字型.

变更记事

						零件图	颜色		SCALE	1:1
						X.	COLOR		UNIT	mm
						X.X	材质		SIZE	A4
						X.XX	MATERIAL		SHEET	1/1
						X.XXX	设计	胡丹桂	PROJ.	11/06/29
						Angle	DESING			
A0	07/07/10		NEW			X.	审核			
版次	日期		变更说明	变更	核准	DIM	CHECK			
REV	DATE		MODIFICATION DESCRIPTION	CHANGE	APPROVE	TOL	核准			
							APPROVE			

WCON

WCON ELECTRONICS (GUANGDONG) CO. LTD

料号 PART NO. 3135-XXSXXBK00X2

品名 TITLE: 1. 27筒牛, 180度DIP, H=9.9 包装规范